

O-linked glycosylation of mucins

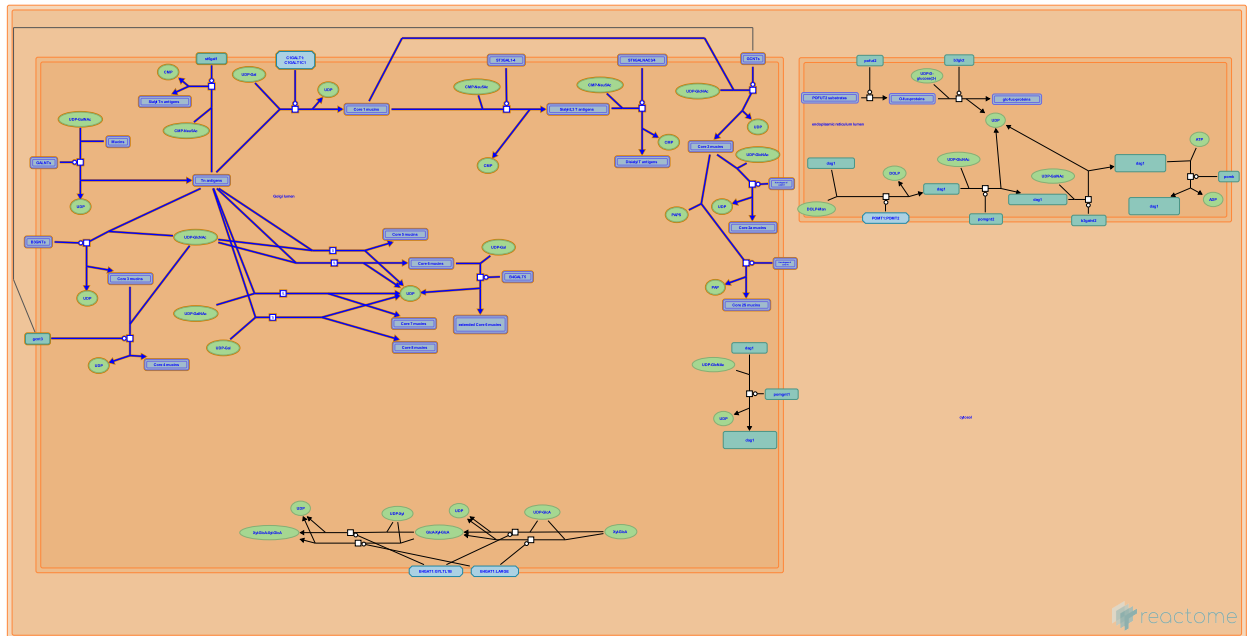

European Bioinformatics Institute, New York University Langone Medical Center, Ontario Institute for Cancer Research, Oregon Health and Science University.

The contents of this document may be freely copied and distributed in any media, provided the authors, plus the institutions, are credited, as stated under the terms of [Creative Commons Attribution 4.0 International \(CC BY 4.0\) License](https://creativecommons.org/licenses/by/4.0/). For more information see our [license](https://reactome.org/licenses/).

This is just an excerpt of a full-length report for this pathway. To access the complete report, please download it at the [Reactome Textbook](https://reactome.org/textbook/).

04/05/2024

Introduction

Reactome is open-source, open access, manually curated and peer-reviewed pathway database. Pathway annotations are authored by expert biologists, in collaboration with Reactome editorial staff and cross-referenced to many bioinformatics databases. A system of evidence tracking ensures that all assertions are backed up by the primary literature. Reactome is used by clinicians, geneticists, genomics researchers, and molecular biologists to interpret the results of high-throughput experimental studies, by bioinformaticians seeking to develop novel algorithms for mining knowledge from genomic studies, and by systems biologists building predictive models of normal and disease variant pathways.

The development of Reactome is supported by grants from the US National Institutes of Health (P41 HG003751), University of Toronto (CFREF Medicine by Design), European Union (EU STRP, EMI-CD), and the European Molecular Biology Laboratory (EBI Industry program).

Literature references

- Fabregat, A., Sidiropoulos, K., Viteri, G., Forner, O., Marin-Garcia, P., Arnau, V. et al. (2017). Reactome pathway analysis: a high-performance in-memory approach. *BMC bioinformatics*, 18, 142. [↗](#)
- Sidiropoulos, K., Viteri, G., Sevilla, C., Jupe, S., Webber, M., Orlic-Milacic, M. et al. (2017). Reactome enhanced pathway visualization. *Bioinformatics*, 33, 3461-3467. [↗](#)
- Fabregat, A., Jupe, S., Matthews, L., Sidiropoulos, K., Gillespie, M., Garapati, P. et al. (2018). The Reactome Pathway Knowledgebase. *Nucleic Acids Res*, 46, D649-D655. [↗](#)
- Fabregat, A., Korninger, F., Viteri, G., Sidiropoulos, K., Marin-Garcia, P., Ping, P. et al. (2018). Reactome graph database: Efficient access to complex pathway data. *PLoS computational biology*, 14, e1005968. [↗](#)

Reactome database release: 88

This document contains 2 pathways and 12 reactions ([see Table of Contents](#))

GALNTs transfer GalNAc to Mucins to form Tn antigens ↗

Location: O-linked glycosylation of mucins

Stable identifier: R-XTR-913675

Type: transition

Compartments: Golgi lumen, Golgi membrane

Inferred from: GALNTs transfer GalNAc to Mucins to form Tn antigens (Homo sapiens)

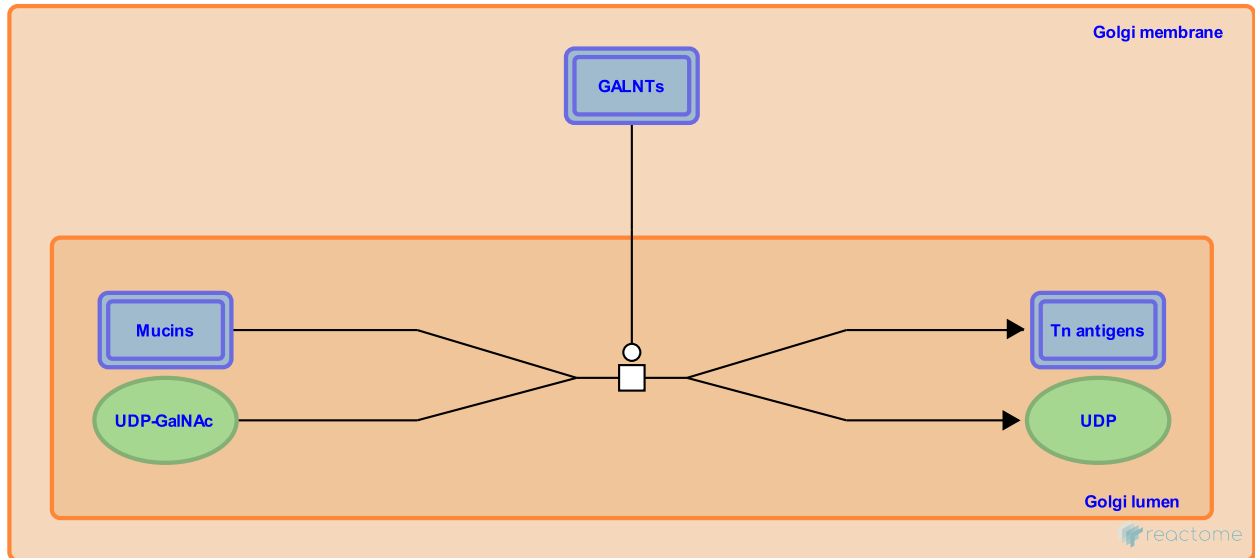

This event has been computationally inferred from an event that has been demonstrated in another species.

The inference is based on the homology mapping from PANTHER. Briefly, reactions for which all involved PhysicalEntities (in input, output and catalyst) have a mapped orthologue/paralogue (for complexes at least 75% of components must have a mapping) are inferred to the other species. High level events are also inferred for these events to allow for easier navigation.

[More details and caveats of the event inference in Reactome.](http://www.pantherdb.org/about.jsp) For details on PANTHER see also: <http://www.pantherdb.org/about.jsp>

Followed by: Addition of galactose to the Tn antigen via an alpha-1,3 linkage forms a Core 8 glycoprotein, Addition of GlcNAc to the Tn antigen via an alpha-1,3 linkage forms a Core 5 glycoprotein, Addition of GlcNAc to the Tn antigen forms a Core 3 glycoprotein, Addition of GalNAc to the Tn antigen via an alpha-1,6 linkage forms a Core 7 glycoprotein, Addition of GlcNAc to the Tn antigen via a beta-1,6 linkage forms a Core 6 glycoprotein, C1GALT1 transfers Galactose to the Tn antigen forming Core 1 glycoproteins (T antigens)

C1GALT1 transfers Galactose to the Tn antigen forming Core 1 glycoproteins (T antigens) ↗

Location: O-linked glycosylation of mucins

Stable identifier: R-XTR-1964505

Type: transition

Compartments: Golgi lumen, Golgi membrane

Inferred from: C1GALT1 transfers Galactose to the Tn antigen forming Core 1 glycoproteins (T antigens) (Homo sapiens)

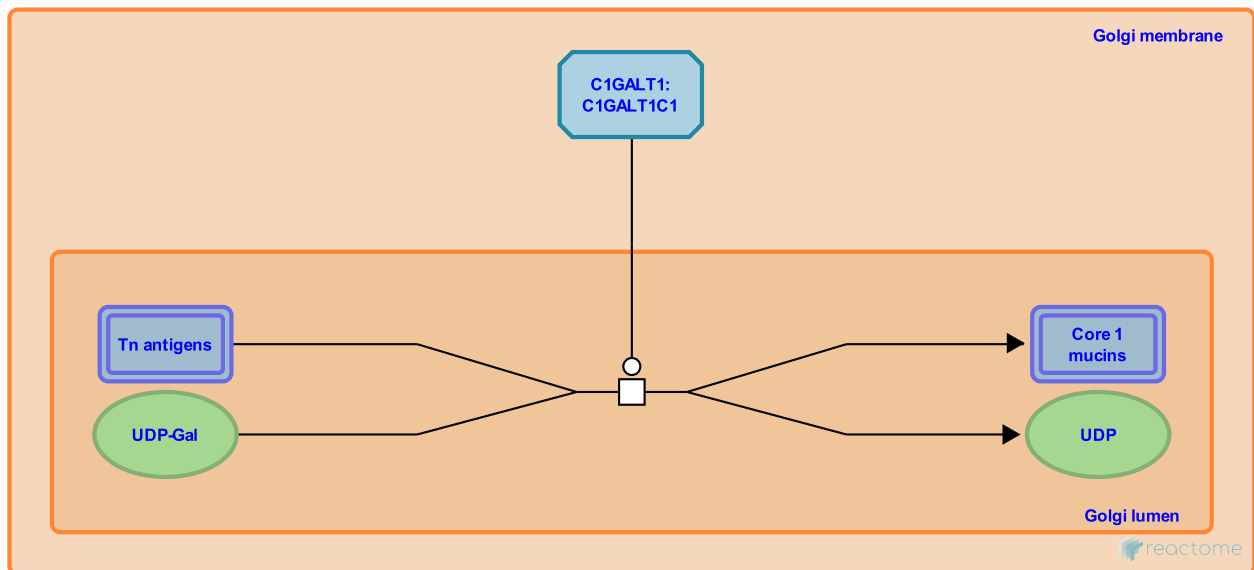

This event has been computationally inferred from an event that has been demonstrated in another species.

The inference is based on the homology mapping from PANTHER. Briefly, reactions for which all involved PhysicalEntities (in input, output and catalyst) have a mapped orthologue/paralogue (for complexes at least 75% of components must have a mapping) are inferred to the other species. High level events are also inferred for these events to allow for easier navigation.

[More details and caveats of the event inference in Reactome.](http://www.pantherdb.org/about.jsp) For details on PANTHER see also: <http://www.pantherdb.org/about.jsp>

Preceded by: GALNTs transfer GalNAc to Mucins to form Tn antigens

Followed by: GCNTs transfer GlcNAc from UDP-GlcNAc to Core 1 mucins

GCNTs transfer GlcNAc from UDP-GlcNAc to Core 1 mucins ↗

Location: O-linked glycosylation of mucins

Stable identifier: R-XTR-914012

Type: transition

Compartments: Golgi membrane, Golgi lumen

Inferred from: GCNTs transfer GlcNAc from UDP-GlcNAc to Core 1 mucins (Homo sapiens)

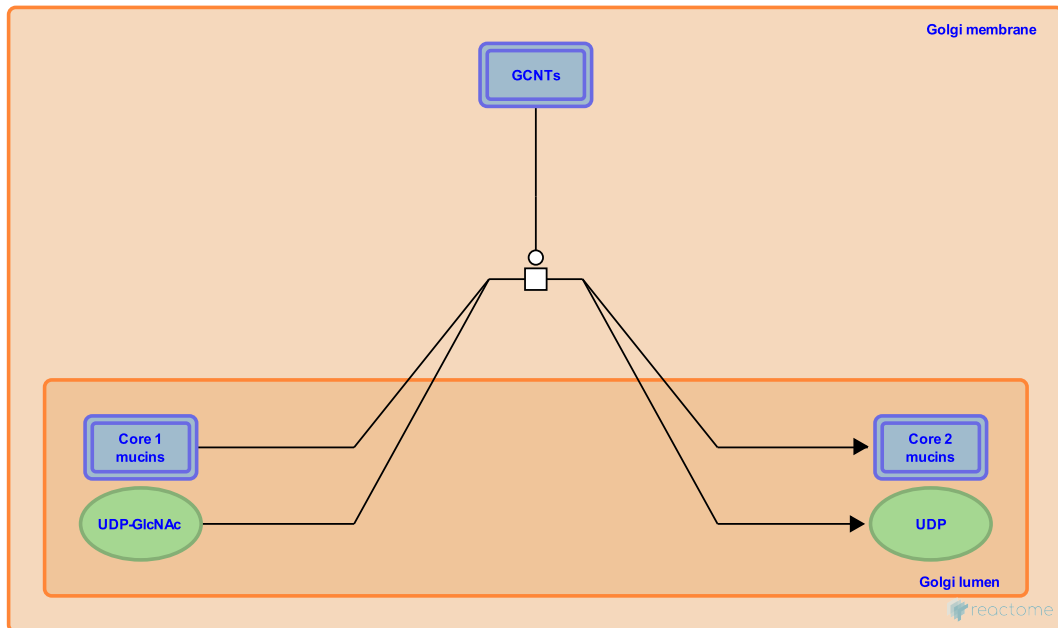

This event has been computationally inferred from an event that has been demonstrated in another species.

The inference is based on the homology mapping from PANTHER. Briefly, reactions for which all involved PhysicalEntities (in input, output and catalyst) have a mapped orthologue/paralogue (for complexes at least 75% of components must have a mapping) are inferred to the other species. High level events are also inferred for these events to allow for easier navigation.

[More details and caveats of the event inference in Reactome.](http://www.pantherdb.org/about.jsp) For details on PANTHER see also: <http://www.pantherdb.org/about.jsp>

Preceded by: C1GALT1 transfers Galactose to the Tn antigen forming Core 1 glycoproteins (T antigens)

Followed by: CHST4 transfers SO₄(2-) from PAPS to Core 2 mucins

CHST4 transfers SO4(2-) from PAPS to Core 2 mucins ↗

Location: O-linked glycosylation of mucins

Stable identifier: R-XTR-6786012

Type: transition

Compartments: Golgi lumen, Golgi membrane

Inferred from: CHST4 transfers SO4(2-) from PAPS to Core 2 mucins (Homo sapiens)

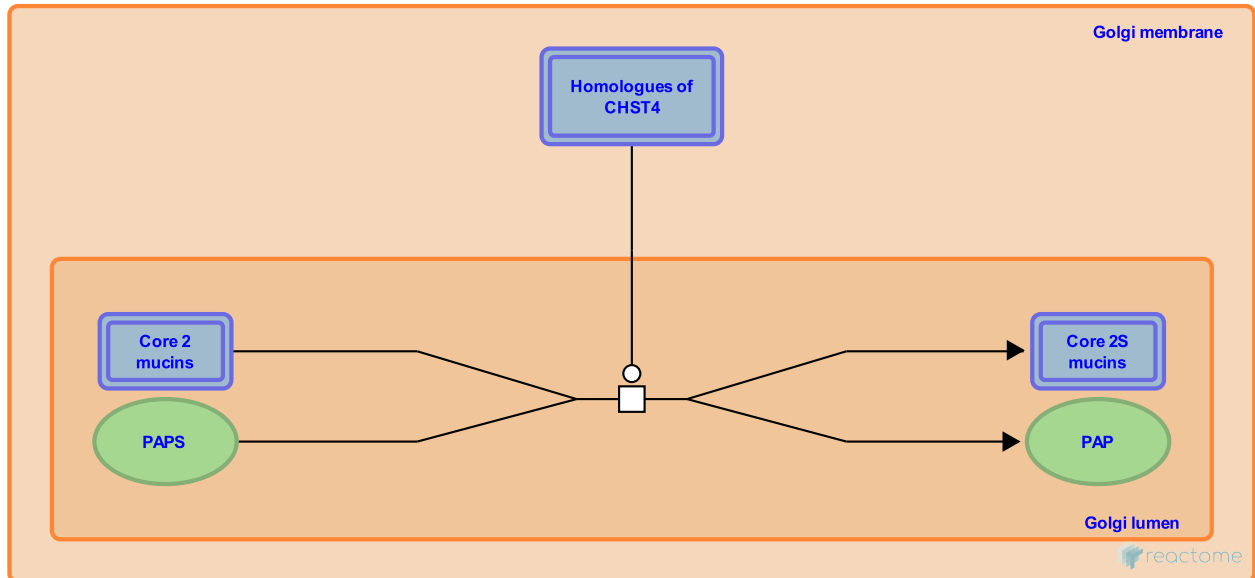

This event has been computationally inferred from an event that has been demonstrated in another species.

The inference is based on the homology mapping from PANTHER. Briefly, reactions for which all involved PhysicalEntities (in input, output and catalyst) have a mapped orthologue/paralogue (for complexes at least 75% of components must have a mapping) are inferred to the other species. High level events are also inferred for these events to allow for easier navigation.

[More details and caveats of the event inference in Reactome.](#) For details on PANTHER see also: <http://www.pantherdb.org/about.jsp>

Preceded by: GCNTs transfer GlcNAc from UDP-GlcNAc to Core 1 mucins

A4GNT transfers GlcNAc to core 2 mucins ↗

Location: O-linked glycosylation of mucins

Stable identifier: R-XTR-5694487

Type: transition

Compartments: Golgi lumen, Golgi membrane

Inferred from: A4GNT transfers GlcNAc to core 2 mucins (Homo sapiens)

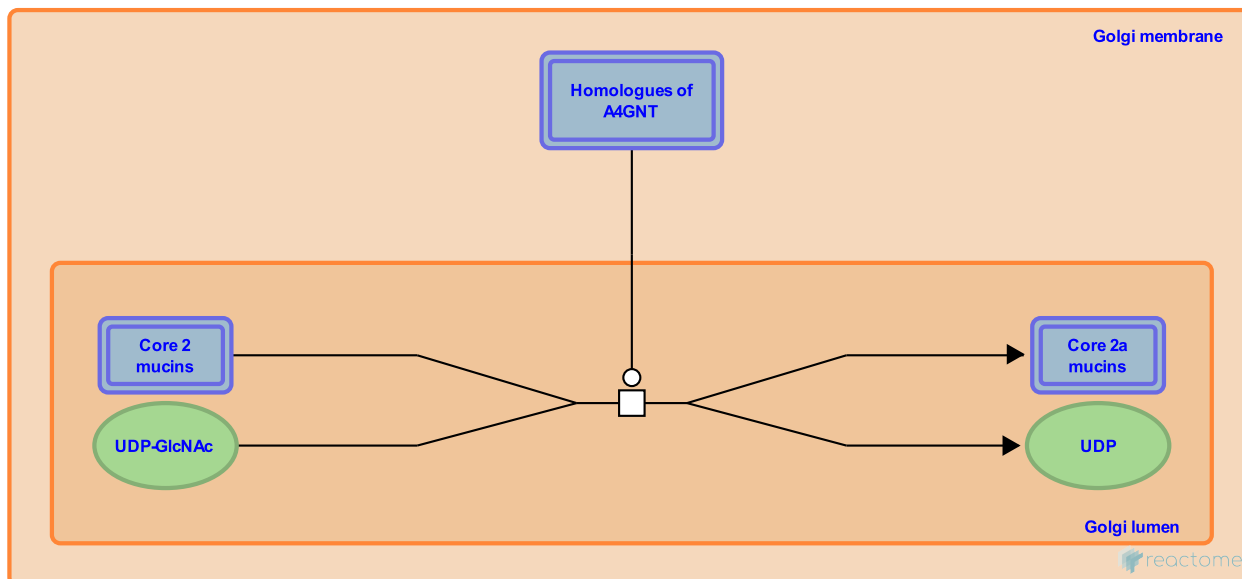

This event has been computationally inferred from an event that has been demonstrated in another species.

The inference is based on the homology mapping from PANTHER. Briefly, reactions for which all involved PhysicalEntities (in input, output and catalyst) have a mapped orthologue/paralogue (for complexes at least 75% of components must have a mapping) are inferred to the other species. High level events are also inferred for these events to allow for easier navigation.

[More details and caveats of the event inference in Reactome.](http://www.pantherdb.org/about.jsp) For details on PANTHER see also: <http://www.pantherdb.org/about.jsp>

Addition of GlcNAc to the Tn antigen forms a Core 3 glycoprotein ↗

Location: O-linked glycosylation of mucins

Stable identifier: R-XTR-914010

Type: transition

Compartments: Golgi lumen, Golgi membrane

Inferred from: Addition of GlcNAc to the Tn antigen forms a Core 3 glycoprotein (Homo sapiens)

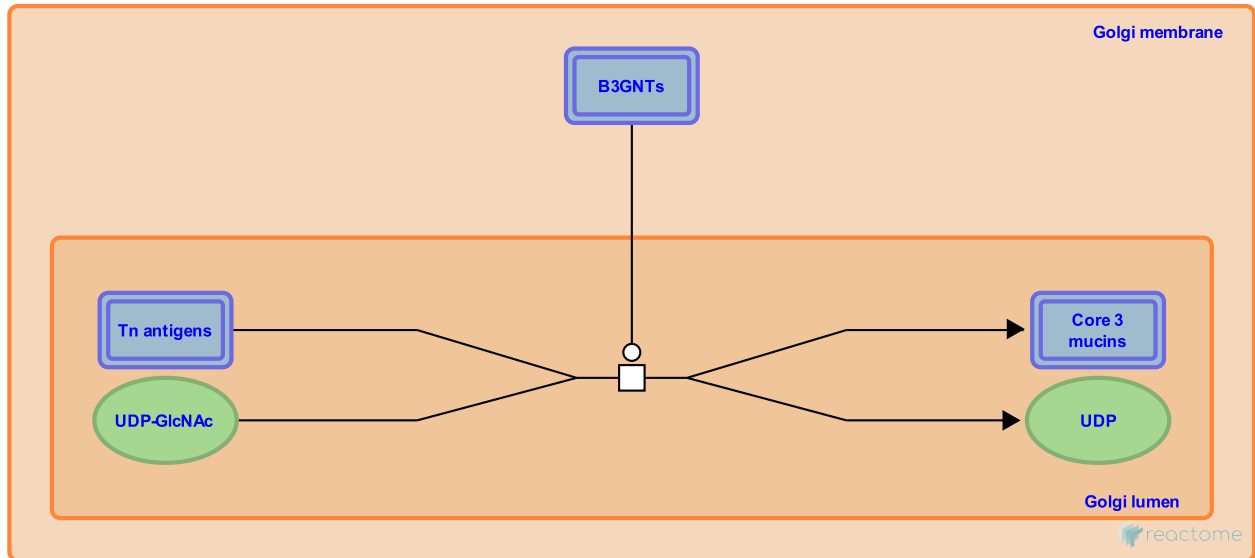

This event has been computationally inferred from an event that has been demonstrated in another species.

The inference is based on the homology mapping from PANTHER. Briefly, reactions for which all involved PhysicalEntities (in input, output and catalyst) have a mapped orthologue/paralogue (for complexes at least 75% of components must have a mapping) are inferred to the other species. High level events are also inferred for these events to allow for easier navigation.

[More details and caveats of the event inference in Reactome.](http://www.pantherdb.org/about.jsp) For details on PANTHER see also: <http://www.pantherdb.org/about.jsp>

Preceded by: GALNTs transfer GalNAc to Mucins to form Tn antigens

Followed by: Addition of GlcNAc to Core 3 forms a Core 4 glycoprotein

Addition of GlcNAc to Core 3 forms a Core 4 glycoprotein ↗

Location: O-linked glycosylation of mucins

Stable identifier: R-XTR-914018

Type: transition

Compartments: Golgi lumen, Golgi membrane

Inferred from: Addition of GlcNAc to Core 3 forms a Core 4 glycoprotein (Homo sapiens)

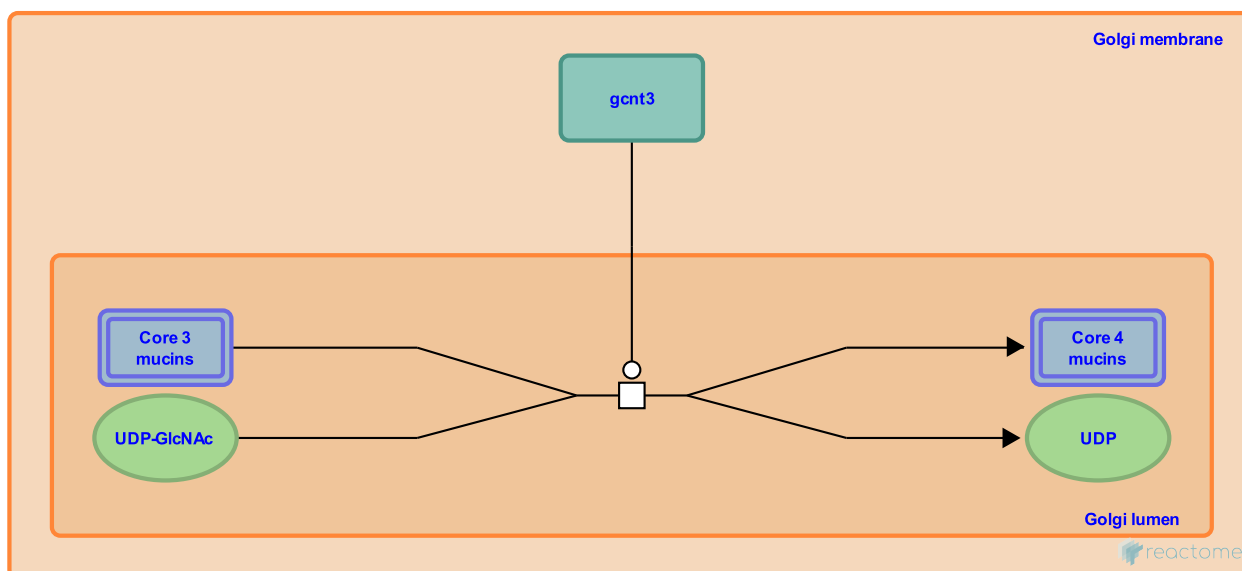

This event has been computationally inferred from an event that has been demonstrated in another species.

The inference is based on the homology mapping from PANTHER. Briefly, reactions for which all involved PhysicalEntities (in input, output and catalyst) have a mapped orthologue/paralogue (for complexes at least 75% of components must have a mapping) are inferred to the other species. High level events are also inferred for these events to allow for easier navigation.

[More details and caveats of the event inference in Reactome.](http://www.pantherdb.org/about.jsp) For details on PANTHER see also: <http://www.pantherdb.org/about.jsp>

Preceded by: Addition of GlcNAc to the Tn antigen forms a Core 3 glycoprotein

Addition of GlcNAc to the Tn antigen via an alpha-1,3 linkage forms a Core 5 glycoprotein [↗](#)

Location: O-linked glycosylation of mucins

Stable identifier: R-XTR-914005

Type: omitted

Compartments: Golgi lumen

Inferred from: Addition of GlcNAc to the Tn antigen via an alpha-1,3 linkage forms a Core 5 glycoprotein (Homo sapiens)

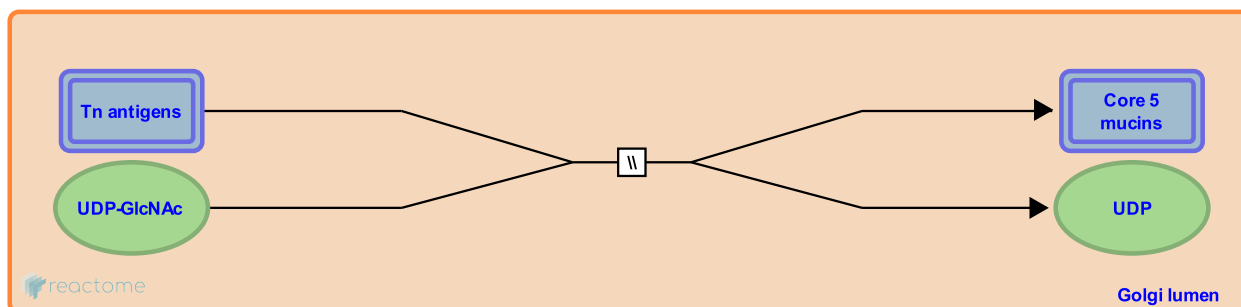

This event has been computationally inferred from an event that has been demonstrated in another species.

The inference is based on the homology mapping from PANTHER. Briefly, reactions for which all involved PhysicalEntities (in input, output and catalyst) have a mapped orthologue/paralogue (for complexes at least 75% of components must have a mapping) are inferred to the other species. High level events are also inferred for these events to allow for easier navigation.

[More details and caveats of the event inference in Reactome.](#) For details on PANTHER see also: <http://www.pantherdb.org/about.jsp>

Preceded by: GALNTs transfer GalNAc to Mucins to form Tn antigens

Addition of GlcNAc to the Tn antigen via a beta-1,6 linkage forms a Core 6 glycoprotein ↗

Location: O-linked glycosylation of mucins

Stable identifier: R-XTR-914008

Type: omitted

Compartments: Golgi lumen

Inferred from: Addition of GlcNAc to the Tn antigen via a beta-1,6 linkage forms a Core 6 glycoprotein (Homo sapiens)

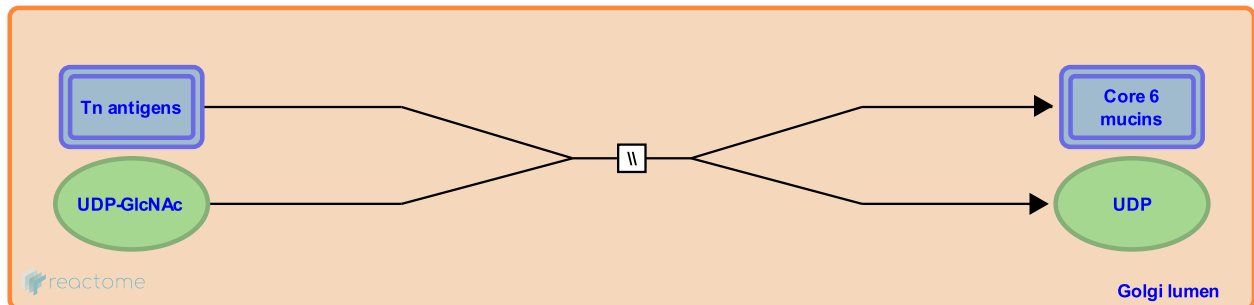

This event has been computationally inferred from an event that has been demonstrated in another species.

The inference is based on the homology mapping from PANTHER. Briefly, reactions for which all involved PhysicalEntities (in input, output and catalyst) have a mapped orthologue/paralogue (for complexes at least 75% of components must have a mapping) are inferred to the other species. High level events are also inferred for these events to allow for easier navigation.

[More details and caveats of the event inference in Reactome.](http://www.pantherdb.org/about.jsp) For details on PANTHER see also: <http://www.pantherdb.org/about.jsp>

Preceded by: GALNTs transfer GalNAc to Mucins to form Tn antigens

Followed by: Addition of galactose to Core 6 glycoprotein

Addition of galactose to Core 6 glycoprotein ↗

Location: O-linked glycosylation of mucins

Stable identifier: R-XTR-1964501

Type: transition

Compartments: Golgi membrane, Golgi lumen

Inferred from: Addition of galactose to Core 6 glycoprotein (Homo sapiens)

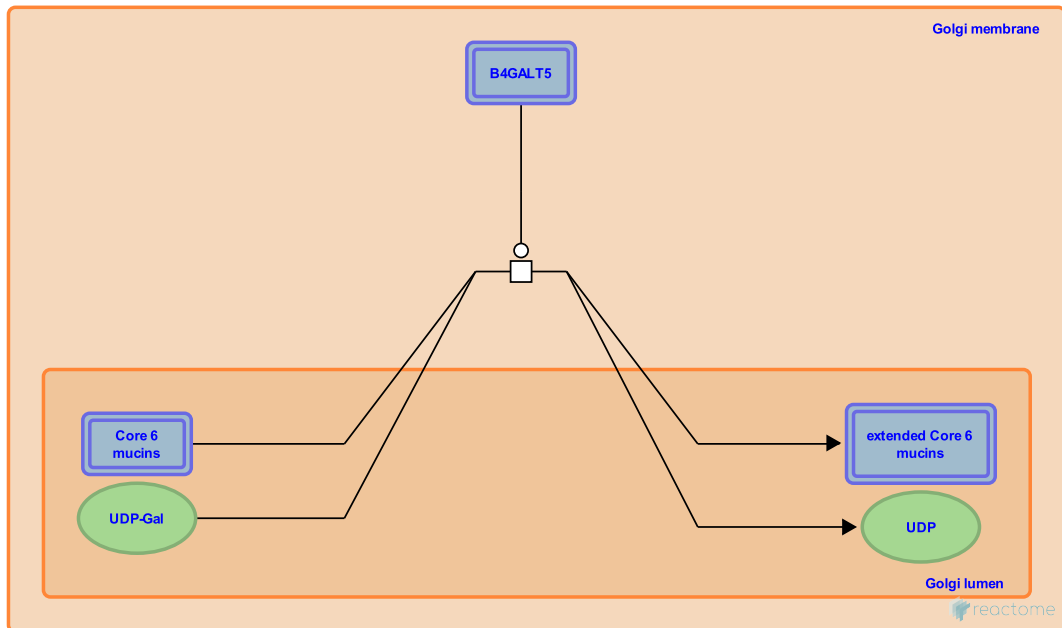

This event has been computationally inferred from an event that has been demonstrated in another species.

The inference is based on the homology mapping from PANTHER. Briefly, reactions for which all involved PhysicalEntities (in input, output and catalyst) have a mapped orthologue/paralogue (for complexes at least 75% of components must have a mapping) are inferred to the other species. High level events are also inferred for these events to allow for easier navigation.

[More details and caveats of the event inference in Reactome.](http://www.pantherdb.org/about.jsp) For details on PANTHER see also: <http://www.pantherdb.org/about.jsp>

Preceded by: Addition of GlcNAc to the Tn antigen via a beta-1,6 linkage forms a Core 6 glycoprotein

Addition of GalNAc to the Tn antigen via an alpha-1,6 linkage forms a Core 7 glycoprotein [↗](#)

Location: O-linked glycosylation of mucins

Stable identifier: R-XTR-914017

Type: omitted

Compartments: Golgi lumen

Inferred from: Addition of GalNAc to the Tn antigen via an alpha-1,6 linkage forms a Core 7 glycoprotein (Homo sapiens)

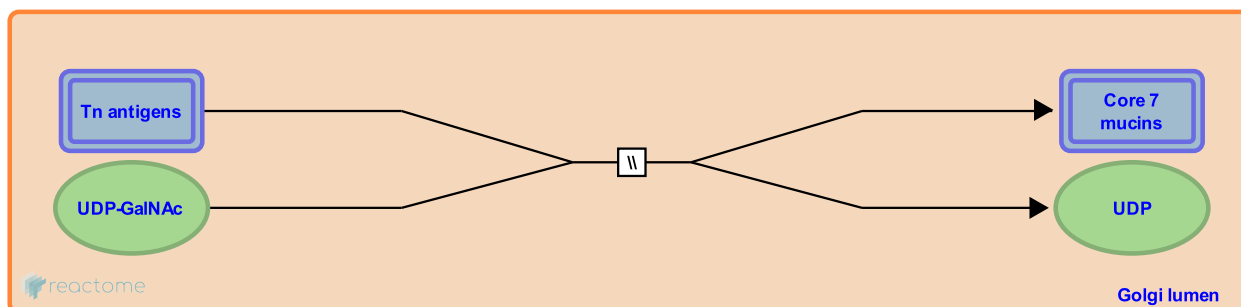

This event has been computationally inferred from an event that has been demonstrated in another species.

The inference is based on the homology mapping from PANTHER. Briefly, reactions for which all involved PhysicalEntities (in input, output and catalyst) have a mapped orthologue/paralogue (for complexes at least 75% of components must have a mapping) are inferred to the other species. High level events are also inferred for these events to allow for easier navigation.

[More details and caveats of the event inference in Reactome.](#) For details on PANTHER see also: <http://www.pantherdb.org/about.jsp>

Preceded by: GALNTs transfer GalNAc to Mucins to form Tn antigens

Addition of galactose to the Tn antigen via an alpha-1,3 linkage forms a Core 8 glycoprotein ↗

Location: O-linked glycosylation of mucins

Stable identifier: R-XTR-914006

Type: omitted

Compartments: Golgi lumen

Inferred from: Addition of galactose to the Tn antigen via an alpha-1,3 linkage forms a Core 8 glycoprotein (Homo sapiens)

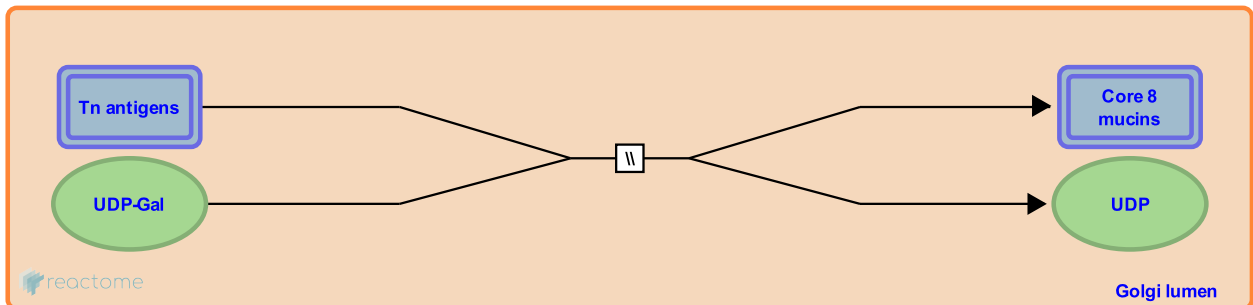

This event has been computationally inferred from an event that has been demonstrated in another species.

The inference is based on the homology mapping from PANTHER. Briefly, reactions for which all involved PhysicalEntities (in input, output and catalyst) have a mapped orthologue/paralogue (for complexes at least 75% of components must have a mapping) are inferred to the other species. High level events are also inferred for these events to allow for easier navigation.

[More details and caveats of the event inference in Reactome.](http://www.pantherdb.org/about.jsp) For details on PANTHER see also: <http://www.pantherdb.org/about.jsp>

Preceded by: GALNTs transfer GalNAc to Mucins to form Tn antigens

Termination of O-glycan biosynthesis ↗

Location: O-linked glycosylation of mucins

Stable identifier: R-XTR-977068

Inferred from: Termination of O-glycan biosynthesis (Homo sapiens)

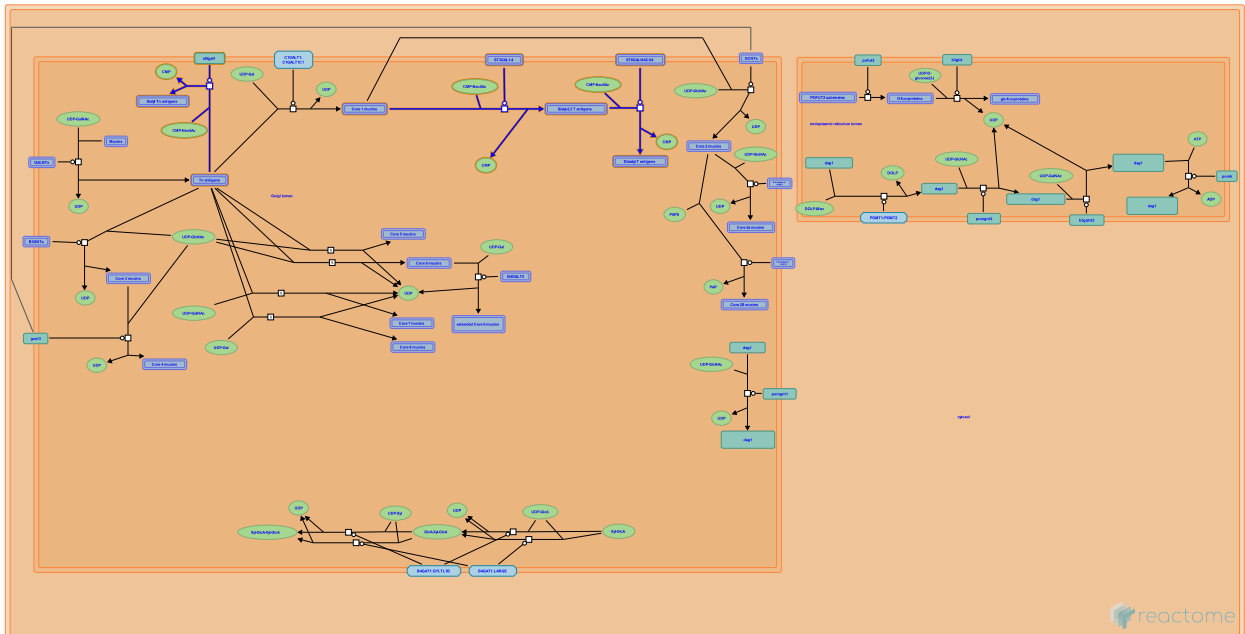

This event has been computationally inferred from an event that has been demonstrated in another species.

The inference is based on the homology mapping from PANTHER. Briefly, reactions for which all involved PhysicalEntities (in input, output and catalyst) have a mapped orthologue/paralogue (for complexes at least 75% of components must have a mapping) are inferred to the other species. High level events are also inferred for these events to allow for easier navigation.

[More details and caveats of the event inference in Reactome.](http://www.pantherdb.org/about.jsp) For details on PANTHER see also: <http://www.pantherdb.org/about.jsp>

Table of Contents

Introduction	1
☒ O-linked glycosylation of mucins	2
↳ GALNTs transfer GalNAc to Mucins to form Tn antigens	3
↳ C1GALT1 transfers Galactose to the Tn antigen forming Core 1 glycoproteins (T antigens)	4
↳ GCNTs transfer GlcNAc from UDP-GlcNAc to Core 1 mucins	5
↳ CHST4 transfers SO ₄ (²⁻) from PAPS to Core 2 mucins	6
↳ A4GNT transfers GlcNAc to core 2 mucins	7
↳ Addition of GlcNAc to the Tn antigen forms a Core 3 glycoprotein	8
↳ Addition of GlcNAc to Core 3 forms a Core 4 glycoprotein	9
☒ Addition of GlcNAc to the Tn antigen via an alpha-1,3 linkage forms a Core 5 glycoprotein	10
☒ Addition of GlcNAc to the Tn antigen via a beta-1,6 linkage forms a Core 6 glycoprotein	11
↳ Addition of galactose to Core 6 glycoprotein	12
☒ Addition of GalNAc to the Tn antigen via an alpha-1,6 linkage forms a Core 7 glycoprotein	13
☒ Addition of galactose to the Tn antigen via an alpha-1,3 linkage forms a Core 8 glycoprotein	14
☒ Termination of O-glycan biosynthesis	15
Table of Contents	16