

Phosphate bond hydrolysis by NTPDase proteins

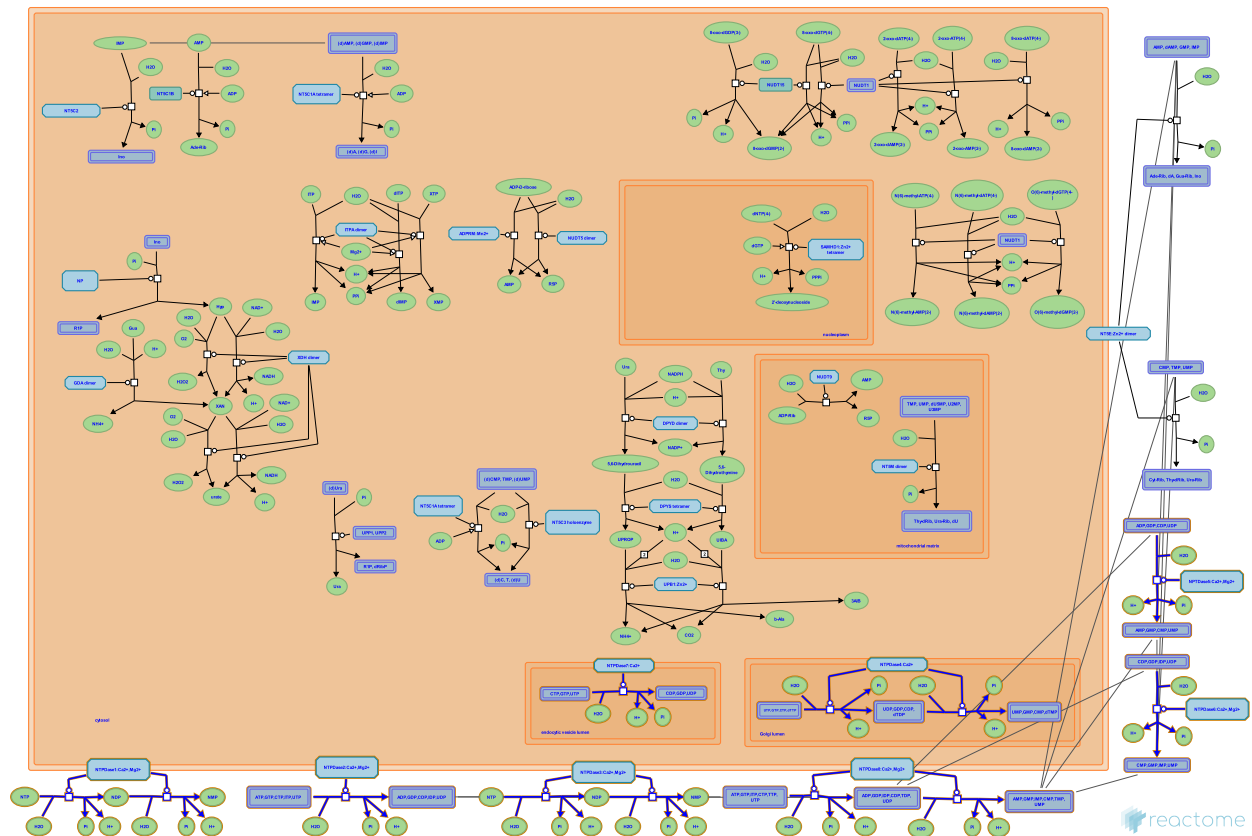

European Bioinformatics Institute, New York University Langone Medical Center, Ontario Institute for Cancer Research, Oregon Health and Science University.

The contents of this document may be freely copied and distributed in any media, provided the authors, plus the institutions, are credited, as stated under the terms of [Creative Commons Attribution 4.0 International \(CC BY 4.0\) License](https://creativecommons.org/licenses/by/4.0/). For more information see our [license](https://reactome.org/licenses/).

This is just an excerpt of a full-length report for this pathway. To access the complete report, please download it at the [Reactome Textbook](https://reactome.org/textbook/).

04/05/2024

Introduction

Reactome is open-source, open access, manually curated and peer-reviewed pathway database. Pathway annotations are authored by expert biologists, in collaboration with Reactome editorial staff and cross-referenced to many bioinformatics databases. A system of evidence tracking ensures that all assertions are backed up by the primary literature. Reactome is used by clinicians, geneticists, genomics researchers, and molecular biologists to interpret the results of high-throughput experimental studies, by bioinformaticians seeking to develop novel algorithms for mining knowledge from genomic studies, and by systems biologists building predictive models of normal and disease variant pathways.

The development of Reactome is supported by grants from the US National Institutes of Health (P41 HG003751), University of Toronto (CFREF Medicine by Design), European Union (EU STRP, EMI-CD), and the European Molecular Biology Laboratory (EBI Industry program).

Literature references

- Fabregat, A., Sidiropoulos, K., Viteri, G., Forner, O., Marin-Garcia, P., Arnau, V. et al. (2017). Reactome pathway analysis: a high-performance in-memory approach. *BMC bioinformatics*, 18, 142. [↗](#)
- Sidiropoulos, K., Viteri, G., Sevilla, C., Jupe, S., Webber, M., Orlic-Milacic, M. et al. (2017). Reactome enhanced pathway visualization. *Bioinformatics*, 33, 3461-3467. [↗](#)
- Fabregat, A., Jupe, S., Matthews, L., Sidiropoulos, K., Gillespie, M., Garapati, P. et al. (2018). The Reactome Pathway Knowledgebase. *Nucleic Acids Res*, 46, D649-D655. [↗](#)
- Fabregat, A., Korninger, F., Viteri, G., Sidiropoulos, K., Marin-Garcia, P., Ping, P. et al. (2018). Reactome graph database: Efficient access to complex pathway data. *PLoS computational biology*, 14, e1005968. [↗](#)

Reactome database release: 88

This document contains 1 pathway and 12 reactions ([see Table of Contents](#))

Phosphate bond hydrolysis by NTPDase proteins ↗

Stable identifier: R-GGA-8850843

Inferred from: Phosphate bond hydrolysis by NTPDase proteins (Homo sapiens)

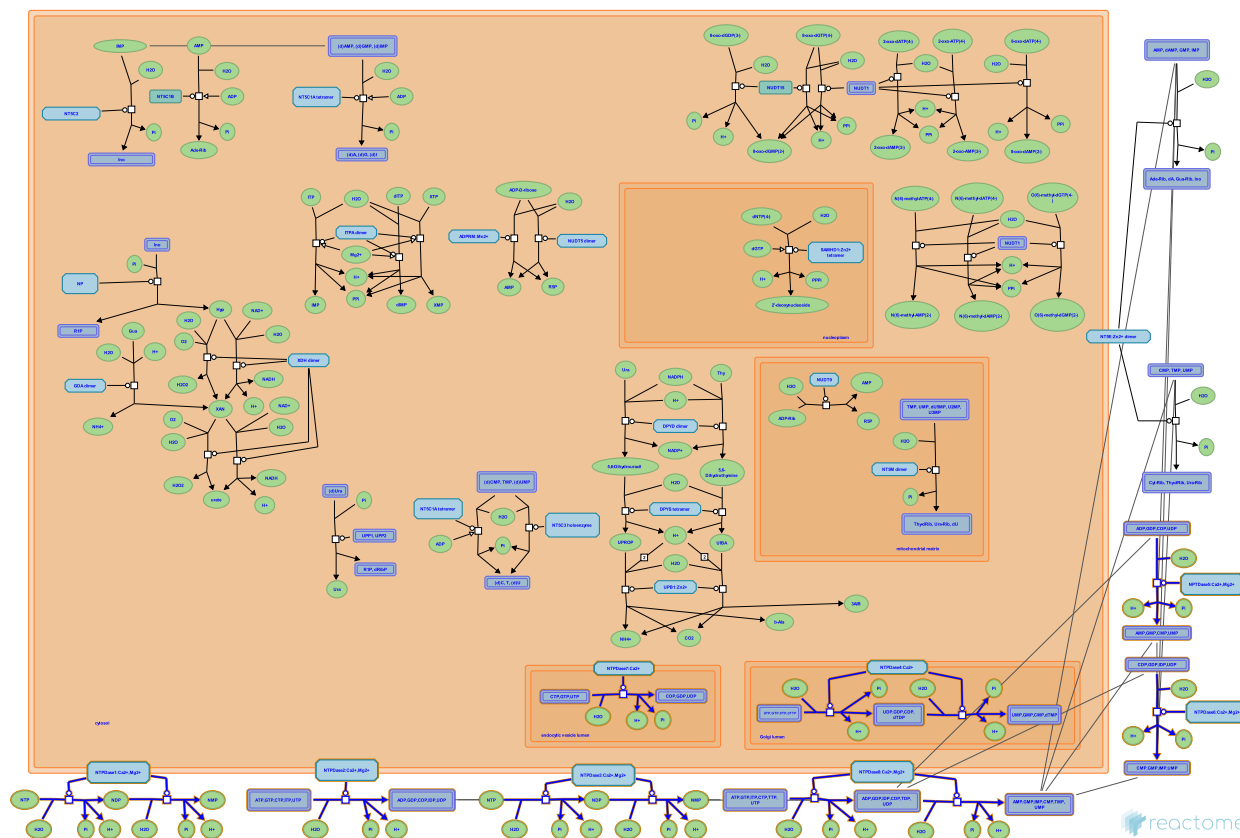

This event has been computationally inferred from an event that has been demonstrated in another species.

The inference is based on the homology mapping from PANTHER. Briefly, reactions for which all involved PhysicalEntities (in input, output and catalyst) have a mapped orthologue/paralogue (for complexes at least 75% of components must have a mapping) are inferred to the other species. High level events are also inferred for these events to allow for easier navigation.

[More details and caveats of the event inference in Reactome.](http://www.pantherdb.org/about.jsp) For details on PANTHER see also: <http://www.pantherdb.org/about.jsp>

NTPDase1 hydrolyzes nucleoside triphosphates ↗

Location: Phosphate bond hydrolysis by NTPDase proteins

Stable identifier: R-GGA-8850846

Type: transition

Compartments: plasma membrane, extracellular region

Inferred from: NTPDase1 hydrolyzes nucleoside triphosphates (Homo sapiens)

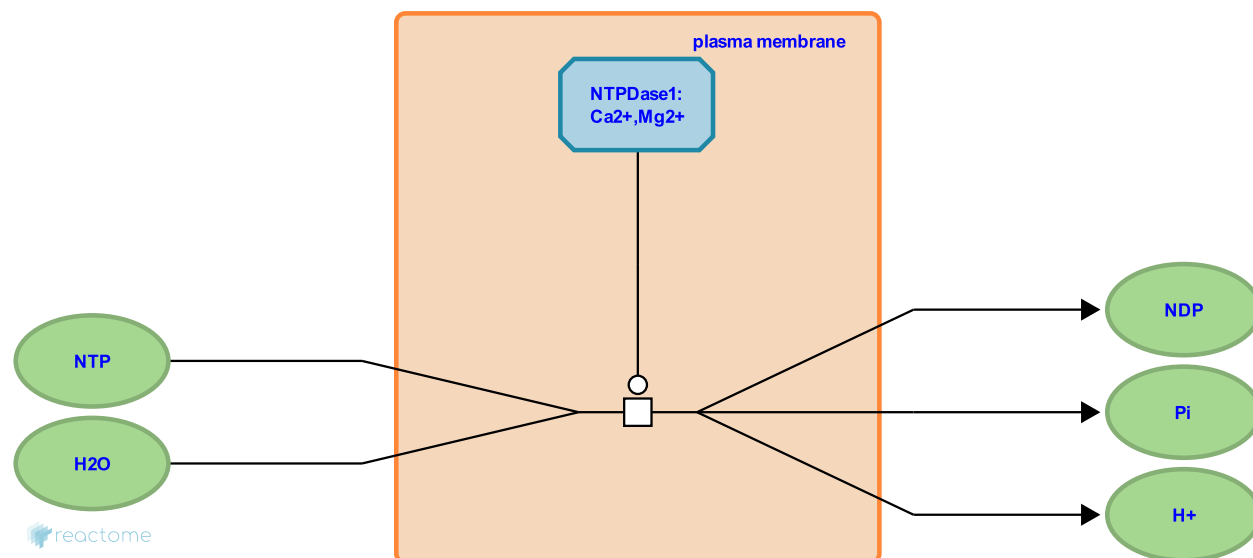

This event has been computationally inferred from an event that has been demonstrated in another species.

The inference is based on the homology mapping from PANTHER. Briefly, reactions for which all involved PhysicalEntities (in input, output and catalyst) have a mapped orthologue/paralogue (for complexes at least 75% of components must have a mapping) are inferred to the other species. High level events are also inferred for these events to allow for easier navigation.

[More details and caveats of the event inference in Reactome.](#) For details on PANTHER see also: <http://www.pantherdb.org/about.jsp>

Followed by: NTPDase1 hydrolyzes nucleoside diphosphates, NTPDase5 hydrolyzes nucleoside diphosphates

NTPDase1 hydrolyzes nucleoside diphosphates ↗

Location: Phosphate bond hydrolysis by NTPDase proteins

Stable identifier: R-GGA-8850854

Type: transition

Compartments: plasma membrane, extracellular region

Inferred from: NTPDase1 hydrolyzes nucleoside diphosphates (Homo sapiens)

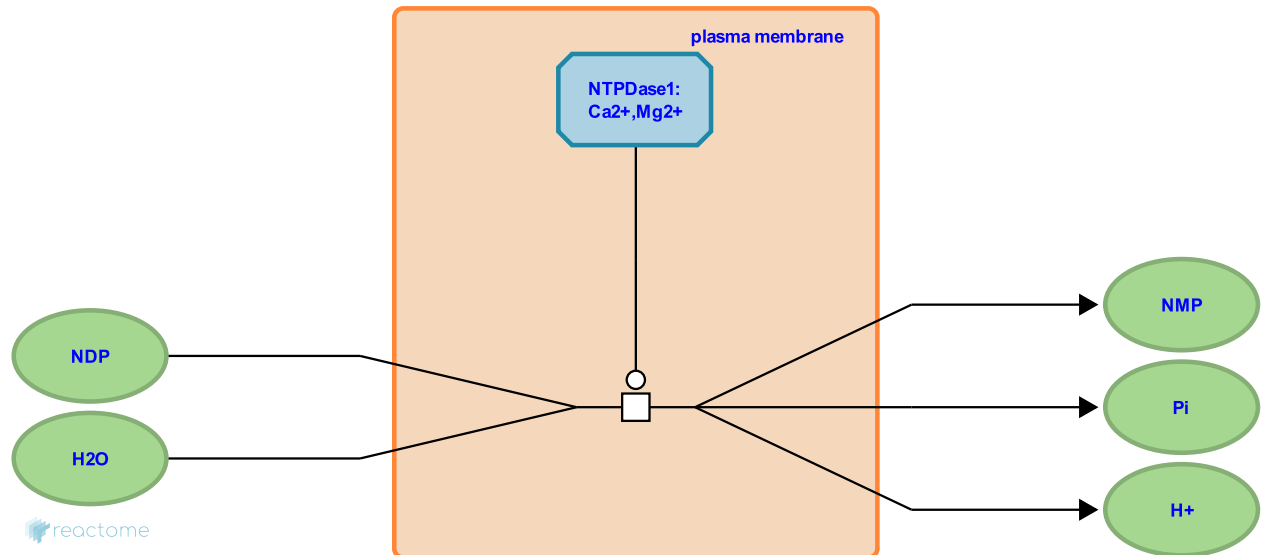

This event has been computationally inferred from an event that has been demonstrated in another species.

The inference is based on the homology mapping from PANTHER. Briefly, reactions for which all involved PhysicalEntities (in input, output and catalyst) have a mapped orthologue/paralogue (for complexes at least 75% of components must have a mapping) are inferred to the other species. High level events are also inferred for these events to allow for easier navigation.

[More details and caveats of the event inference in Reactome.](http://www.pantherdb.org/about.jsp) For details on PANTHER see also: <http://www.pantherdb.org/about.jsp>

Preceded by: NTPDase1 hydrolyzes nucleoside triphosphates

NTPDase2 hydrolyzes nucleoside triphosphates ↗

Location: Phosphate bond hydrolysis by NTPDase proteins

Stable identifier: R-GGA-8851089

Type: transition

Compartments: plasma membrane, extracellular region

Inferred from: NTPDase2 hydrolyzes nucleoside triphosphates (Homo sapiens)

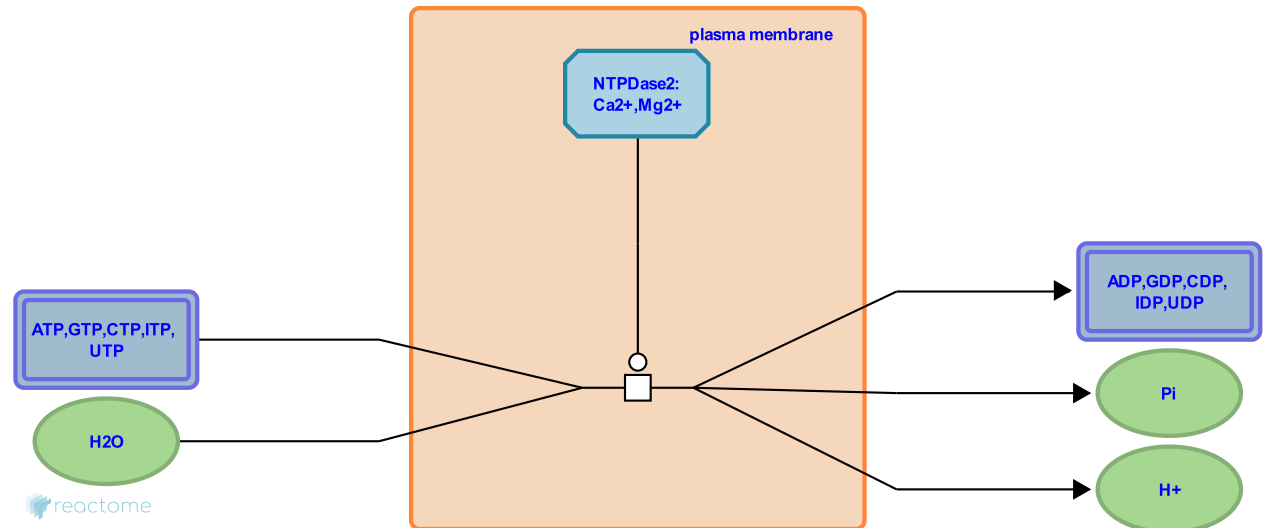

This event has been computationally inferred from an event that has been demonstrated in another species.

The inference is based on the homology mapping from PANTHER. Briefly, reactions for which all involved PhysicalEntities (in input, output and catalyst) have a mapped orthologue/paralogue (for complexes at least 75% of components must have a mapping) are inferred to the other species. High level events are also inferred for these events to allow for easier navigation.

[More details and caveats of the event inference in Reactome.](http://www.pantherdb.org/about.jsp) For details on PANTHER see also: <http://www.pantherdb.org/about.jsp>

NTPDase3 hydrolyzes nucleoside triphosphates ↗

Location: Phosphate bond hydrolysis by NTPDase proteins

Stable identifier: R-GGA-8851110

Type: transition

Compartments: plasma membrane, extracellular region

Inferred from: NTPDase3 hydrolyzes nucleoside triphosphates (Homo sapiens)

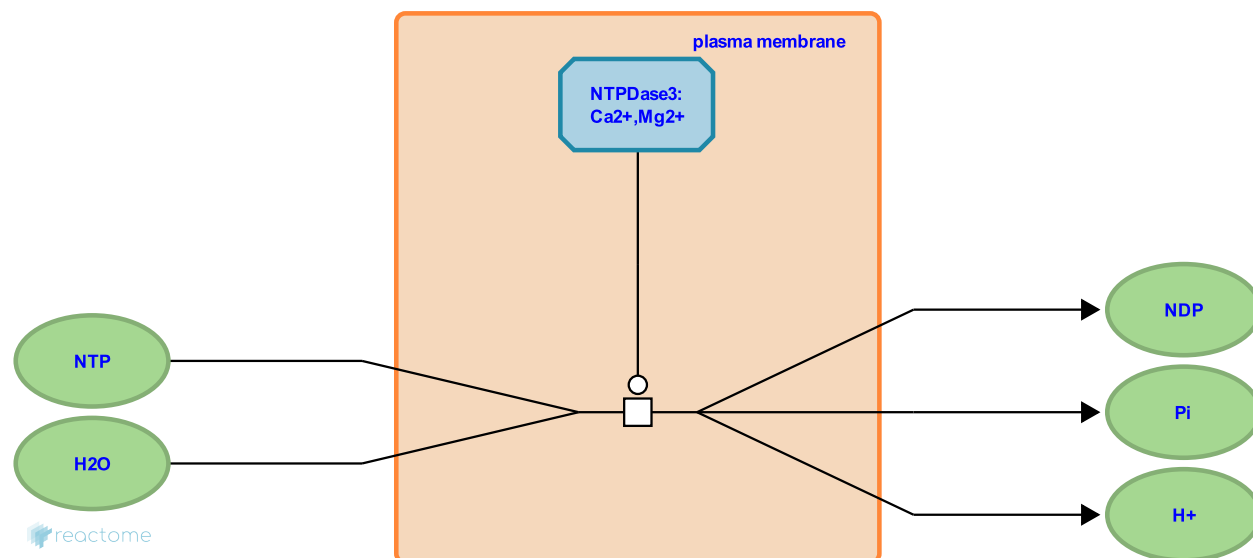

This event has been computationally inferred from an event that has been demonstrated in another species.

The inference is based on the homology mapping from PANTHER. Briefly, reactions for which all involved PhysicalEntities (in input, output and catalyst) have a mapped orthologue/paralogue (for complexes at least 75% of components must have a mapping) are inferred to the other species. High level events are also inferred for these events to allow for easier navigation.

[More details and caveats of the event inference in Reactome.](http://www.pantherdb.org/about.jsp) For details on PANTHER see also: <http://www.pantherdb.org/about.jsp>

Followed by: NTPDase3 hydrolyzes nucleoside diphosphates

NTPDase3 hydrolyzes nucleoside diphosphates ↗

Location: Phosphate bond hydrolysis by NTPDase proteins

Stable identifier: R-GGA-8851129

Type: transition

Compartments: plasma membrane, extracellular region

Inferred from: NTPDase3 hydrolyzes nucleoside diphosphates (Homo sapiens)

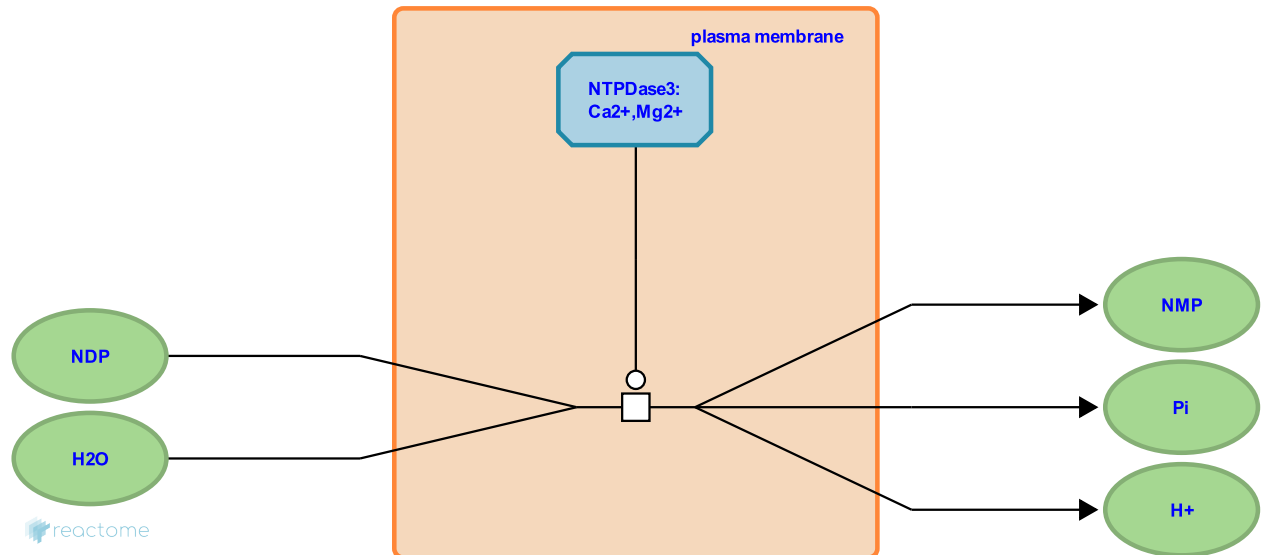

This event has been computationally inferred from an event that has been demonstrated in another species.

The inference is based on the homology mapping from PANTHER. Briefly, reactions for which all involved PhysicalEntities (in input, output and catalyst) have a mapped orthologue/paralogue (for complexes at least 75% of components must have a mapping) are inferred to the other species. High level events are also inferred for these events to allow for easier navigation.

[More details and caveats of the event inference in Reactome.](http://www.pantherdb.org/about.jsp) For details on PANTHER see also: <http://www.pantherdb.org/about.jsp>

Preceded by: NTPDase3 hydrolyzes nucleoside triphosphates

NTPDase4 hydrolyzes nucleoside triphosphates ↗

Location: Phosphate bond hydrolysis by NTPDase proteins

Stable identifier: R-GGA-8851234

Type: transition

Compartments: Golgi membrane, Golgi lumen

Inferred from: NTPDase4 hydrolyzes nucleoside triphosphates (Homo sapiens)

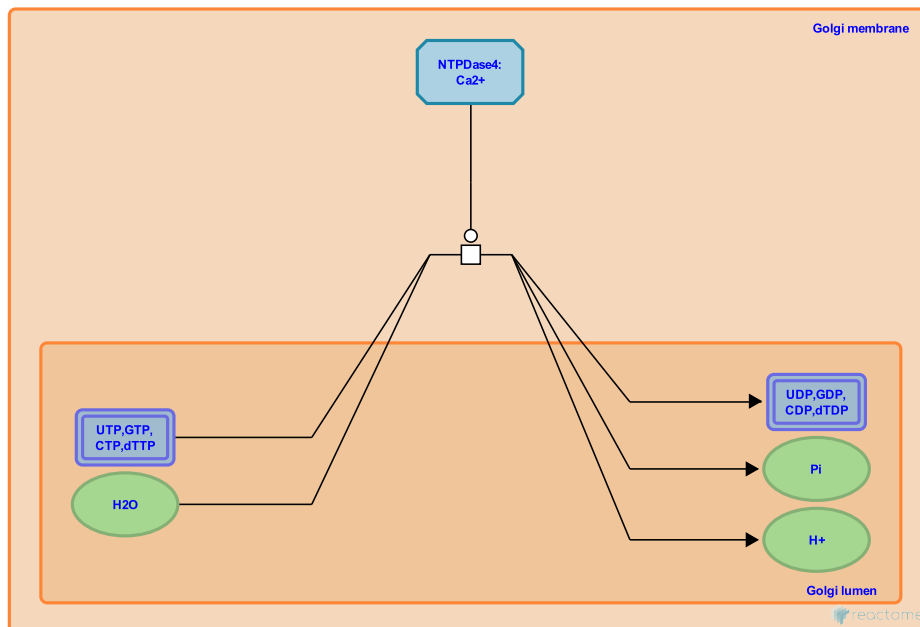

This event has been computationally inferred from an event that has been demonstrated in another species.

The inference is based on the homology mapping from PANTHER. Briefly, reactions for which all involved PhysicalEntities (in input, output and catalyst) have a mapped orthologue/paralogue (for complexes at least 75% of components must have a mapping) are inferred to the other species. High level events are also inferred for these events to allow for easier navigation.

[More details and caveats of the event inference in Reactome.](http://www.pantherdb.org/about.jsp) For details on PANTHER see also: <http://www.pantherdb.org/about.jsp>

Followed by: NTPDase4 hydrolyzes nucleoside diphosphates

NTPDase4 hydrolyzes nucleoside diphosphates ↗

Location: Phosphate bond hydrolysis by NTPDase proteins

Stable identifier: R-GGA-8851225

Type: transition

Compartments: Golgi membrane, Golgi lumen

Inferred from: NTPDase4 hydrolyzes nucleoside diphosphates (Homo sapiens)

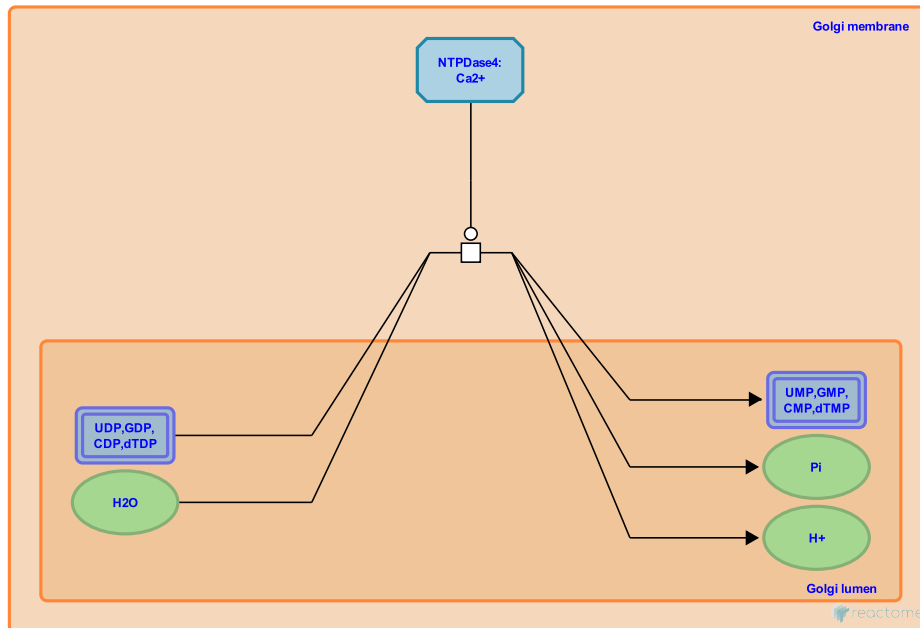

This event has been computationally inferred from an event that has been demonstrated in another species.

The inference is based on the homology mapping from PANTHER. Briefly, reactions for which all involved PhysicalEntities (in input, output and catalyst) have a mapped orthologue/paralogue (for complexes at least 75% of components must have a mapping) are inferred to the other species. High level events are also inferred for these events to allow for easier navigation.

[More details and caveats of the event inference in Reactome.](http://www.pantherdb.org/about.jsp) For details on PANTHER see also: <http://www.pantherdb.org/about.jsp>

Preceded by: NTPDase4 hydrolyzes nucleoside triphosphates

NTPDase5 hydrolyzes nucleoside diphosphates ↗

Location: Phosphate bond hydrolysis by NTPDase proteins

Stable identifier: R-GGA-8851356

Type: transition

Compartments: extracellular region

Inferred from: NTPDase5 hydrolyzes nucleoside diphosphates (Homo sapiens)

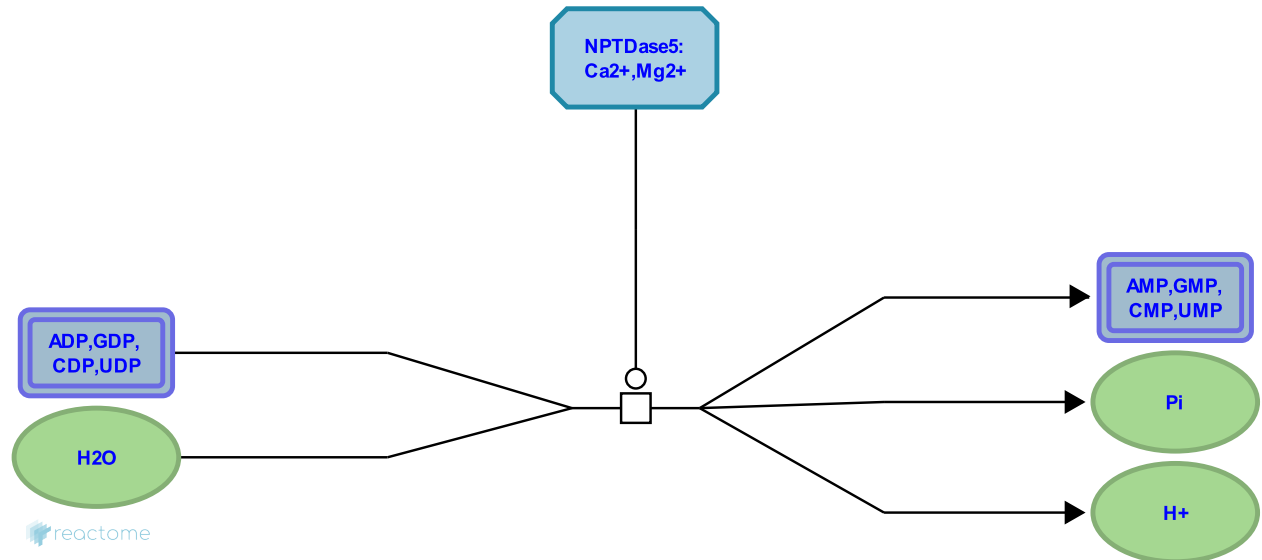

This event has been computationally inferred from an event that has been demonstrated in another species.

The inference is based on the homology mapping from PANTHER. Briefly, reactions for which all involved PhysicalEntities (in input, output and catalyst) have a mapped orthologue/paralogue (for complexes at least 75% of components must have a mapping) are inferred to the other species. High level events are also inferred for these events to allow for easier navigation.

[More details and caveats of the event inference in Reactome.](http://www.pantherdb.org/about.jsp) For details on PANTHER see also: <http://www.pantherdb.org/about.jsp>

Preceded by: NTPDase1 hydrolyzes nucleoside triphosphates

NTPDase6 hydrolyzes nucleoside diphosphates ↗

Location: Phosphate bond hydrolysis by NTPDase proteins

Stable identifier: R-GGA-8851396

Type: transition

Compartments: extracellular region

Inferred from: NTPDase6 hydrolyzes nucleoside diphosphates (Homo sapiens)

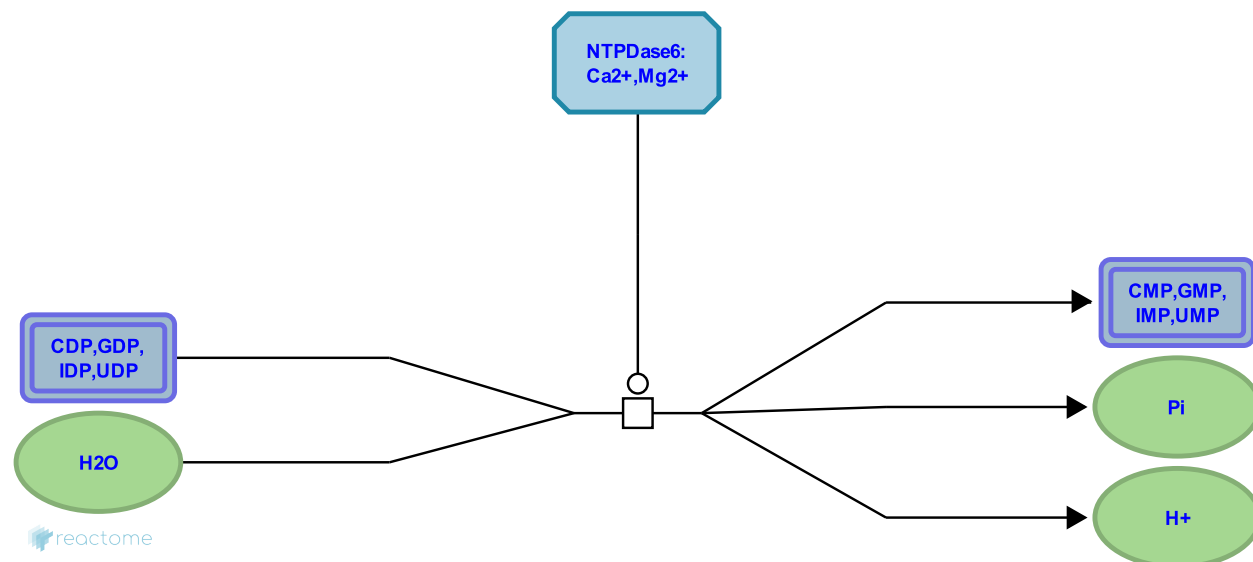

This event has been computationally inferred from an event that has been demonstrated in another species.

The inference is based on the homology mapping from PANTHER. Briefly, reactions for which all involved PhysicalEntities (in input, output and catalyst) have a mapped orthologue/paralogue (for complexes at least 75% of components must have a mapping) are inferred to the other species. High level events are also inferred for these events to allow for easier navigation.

[More details and caveats of the event inference in Reactome.](https://www.reactome.org) For details on PANTHER see also: <http://www.pantherdb.org/about.jsp>

NTPDase7 hydrolyzes nucleoside triphosphates ↗

Location: Phosphate bond hydrolysis by NTPDase proteins

Stable identifier: R-GGA-8851494

Type: transition

Compartments: endocytic vesicle lumen, endocytic vesicle membrane

Inferred from: NTPDase7 hydrolyzes nucleoside triphosphates (Homo sapiens)

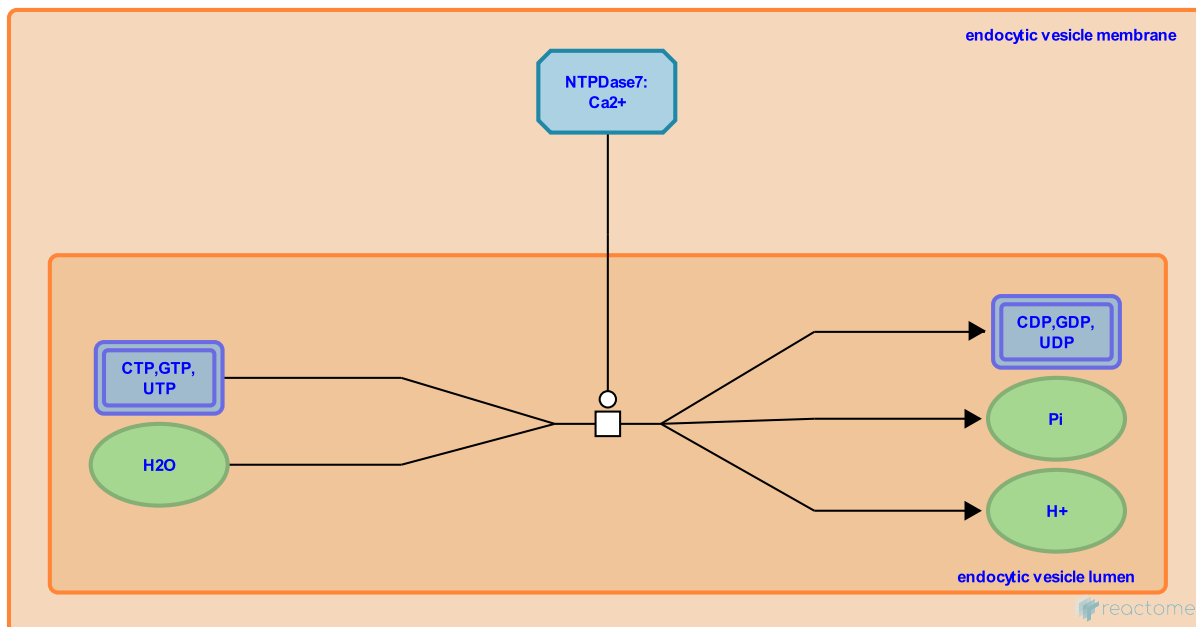

This event has been computationally inferred from an event that has been demonstrated in another species.

The inference is based on the homology mapping from PANTHER. Briefly, reactions for which all involved PhysicalEntities (in input, output and catalyst) have a mapped orthologue/paralogue (for complexes at least 75% of components must have a mapping) are inferred to the other species. High level events are also inferred for these events to allow for easier navigation.

[More details and caveats of the event inference in Reactome.](https://www.reactome.org) For details on PANTHER see also: <http://www.pantherdb.org/about.jsp>

NTPDase8 hydrolyzes nucleoside triphosphates ↗

Location: Phosphate bond hydrolysis by NTPDase proteins

Stable identifier: R-GGA-8851538

Type: transition

Compartments: plasma membrane, extracellular region

Inferred from: NTPDase8 hydrolyzes nucleoside triphosphates (Homo sapiens)

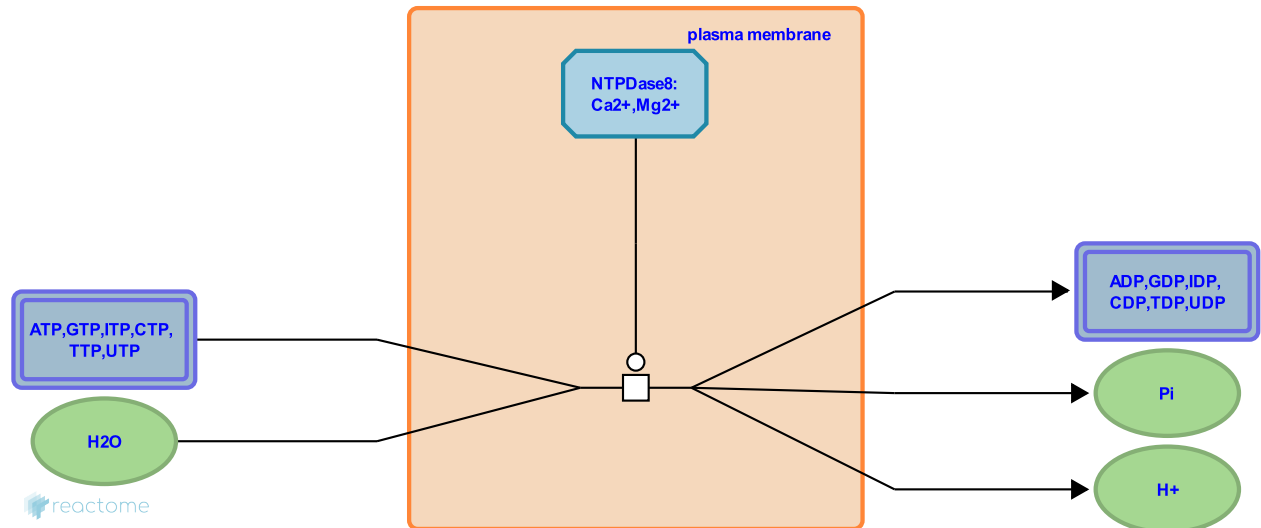

This event has been computationally inferred from an event that has been demonstrated in another species.

The inference is based on the homology mapping from PANTHER. Briefly, reactions for which all involved PhysicalEntities (in input, output and catalyst) have a mapped orthologue/paralogue (for complexes at least 75% of components must have a mapping) are inferred to the other species. High level events are also inferred for these events to allow for easier navigation.

[More details and caveats of the event inference in Reactome.](http://www.pantherdb.org/about.jsp) For details on PANTHER see also: <http://www.pantherdb.org/about.jsp>

Followed by: NTPDase8 hydrolyzes nucleoside diphosphates

NTPDase8 hydrolyzes nucleoside diphosphates ↗

Location: Phosphate bond hydrolysis by NTPDase proteins

Stable identifier: R-GGA-8851550

Type: transition

Compartments: plasma membrane, extracellular region

Inferred from: NTPDase8 hydrolyzes nucleoside diphosphates (Homo sapiens)

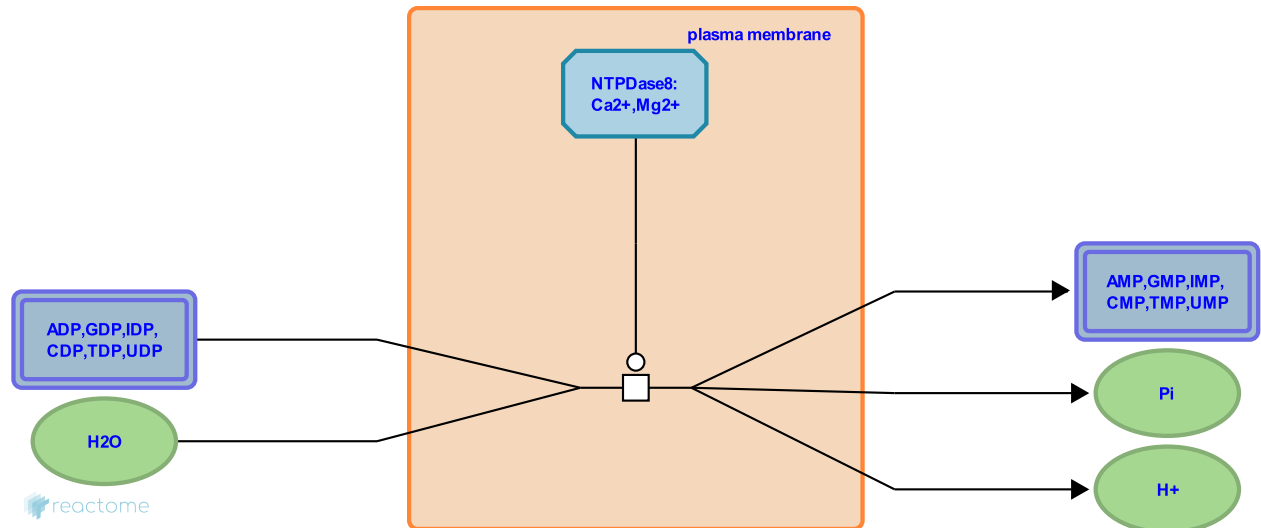

This event has been computationally inferred from an event that has been demonstrated in another species.

The inference is based on the homology mapping from PANTHER. Briefly, reactions for which all involved PhysicalEntities (in input, output and catalyst) have a mapped orthologue/paralogue (for complexes at least 75% of components must have a mapping) are inferred to the other species. High level events are also inferred for these events to allow for easier navigation.

[More details and caveats of the event inference in Reactome.](http://www.pantherdb.org/about.jsp) For details on PANTHER see also: <http://www.pantherdb.org/about.jsp>

Preceded by: NTPDase8 hydrolyzes nucleoside triphosphates

Table of Contents

Introduction	1
☰ Phosphate bond hydrolysis by NTPDase proteins	2
↳ NTPDase1 hydrolyzes nucleoside triphosphates	3
↳ NTPDase1 hydrolyzes nucleoside diphosphates	4
↳ NTPDase2 hydrolyzes nucleoside triphosphates	5
↳ NTPDase3 hydrolyzes nucleoside triphosphates	6
↳ NTPDase3 hydrolyzes nucleoside diphosphates	7
↳ NTPDase4 hydrolyzes nucleoside triphosphates	8
↳ NTPDase4 hydrolyzes nucleoside diphosphates	9
↳ NTPDase5 hydrolyzes nucleoside diphosphates	10
↳ NTPDase6 hydrolyzes nucleoside diphosphates	11
↳ NTPDase7 hydrolyzes nucleoside triphosphates	12
↳ NTPDase8 hydrolyzes nucleoside triphosphates	13
↳ NTPDase8 hydrolyzes nucleoside diphosphates	14
Table of Contents	15