

Metabolism of Angiotensinogen to Angiotensins

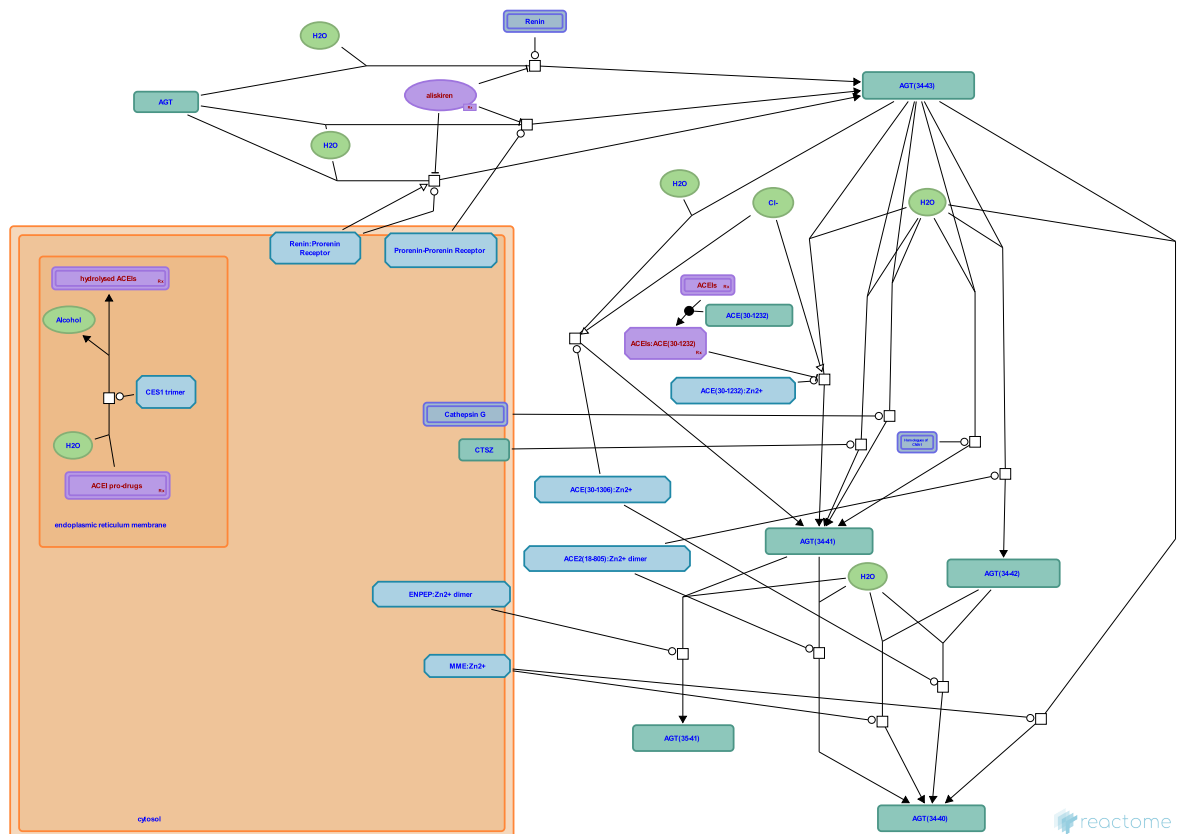

European Bioinformatics Institute, New York University Langone Medical Center, Ontario Institute for Cancer Research, Oregon Health and Science University.

The contents of this document may be freely copied and distributed in any media, provided the authors, plus the institutions, are credited, as stated under the terms of [Creative Commons Attribution 4.0 International \(CC BY 4.0\) License](https://creativecommons.org/licenses/by/4.0/). For more information see our [license](https://reactome.org/licenses/).

This is just an excerpt of a full-length report for this pathway. To access the complete report, please download it at the [Reactome Textbook](https://reactome.org/textbook/).

04/05/2024

Introduction

Reactome is open-source, open access, manually curated and peer-reviewed pathway database. Pathway annotations are authored by expert biologists, in collaboration with Reactome editorial staff and cross-referenced to many bioinformatics databases. A system of evidence tracking ensures that all assertions are backed up by the primary literature. Reactome is used by clinicians, geneticists, genomics researchers, and molecular biologists to interpret the results of high-throughput experimental studies, by bioinformaticians seeking to develop novel algorithms for mining knowledge from genomic studies, and by systems biologists building predictive models of normal and disease variant pathways.

The development of Reactome is supported by grants from the US National Institutes of Health (P41 HG003751), University of Toronto (CFREF Medicine by Design), European Union (EU STRP, EMI-CD), and the European Molecular Biology Laboratory (EBI Industry program).

Literature references

- Fabregat, A., Sidiropoulos, K., Viteri, G., Forner, O., Marin-Garcia, P., Arnau, V. et al. (2017). Reactome pathway analysis: a high-performance in-memory approach. *BMC bioinformatics*, 18, 142. [↗](#)
- Sidiropoulos, K., Viteri, G., Sevilla, C., Jupe, S., Webber, M., Orlic-Milacic, M. et al. (2017). Reactome enhanced pathway visualization. *Bioinformatics*, 33, 3461-3467. [↗](#)
- Fabregat, A., Jupe, S., Matthews, L., Sidiropoulos, K., Gillespie, M., Garapati, P. et al. (2018). The Reactome Pathway Knowledgebase. *Nucleic Acids Res*, 46, D649-D655. [↗](#)
- Fabregat, A., Korninger, F., Viteri, G., Sidiropoulos, K., Marin-Garcia, P., Ping, P. et al. (2018). Reactome graph database: Efficient access to complex pathway data. *PLoS computational biology*, 14, e1005968. [↗](#)

Reactome database release: 88

This document contains 1 pathway and 16 reactions ([see Table of Contents](#))

Metabolism of Angiotensinogen to Angiotensins ↗

Stable identifier: R-GGA-2022377

Compartments: extracellular region, plasma membrane

Inferred from: [Metabolism of Angiotensinogen to Angiotensins \(Homo sapiens\)](#)

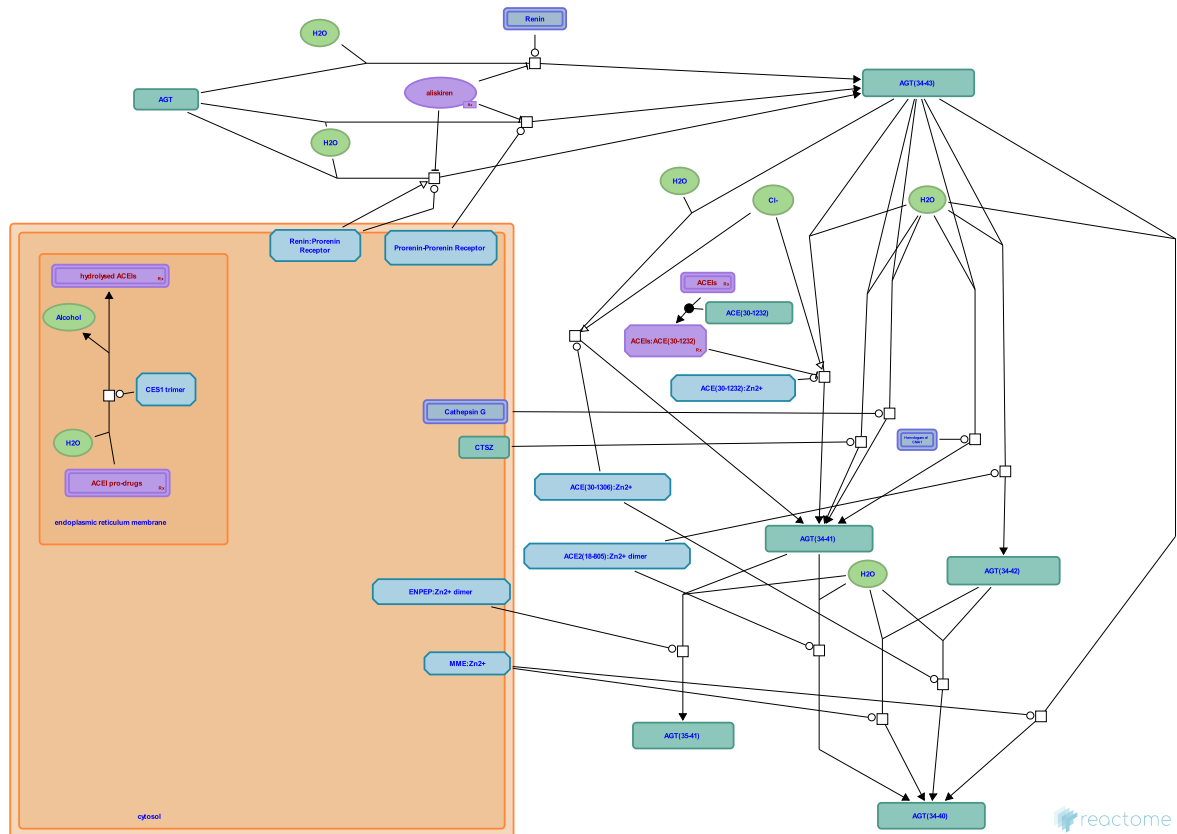

This event has been computationally inferred from an event that has been demonstrated in another species.

The inference is based on the homology mapping from PANTHER. Briefly, reactions for which all involved PhysicalEntities (in input, output and catalyst) have a mapped orthologue/paralogue (for complexes at least 75% of components must have a mapping) are inferred to the other species. High level events are also inferred for these events to allow for easier navigation.

[More details and caveats of the event inference in Reactome.](#) For details on PANTHER see also: <http://www.pantherdb.org/about.jsp>

Renin hydrolyzes Angiotensinogen to Angiotensin-(1-10) ↗

Location: [Metabolism of Angiotensinogen to Angiotensins](#)

Stable identifier: R-GGA-2022412

Type: transition

Compartments: extracellular region

Inferred from: [Renin hydrolyzes Angiotensinogen to Angiotensin-\(1-10\) \(Homo sapiens\)](#)

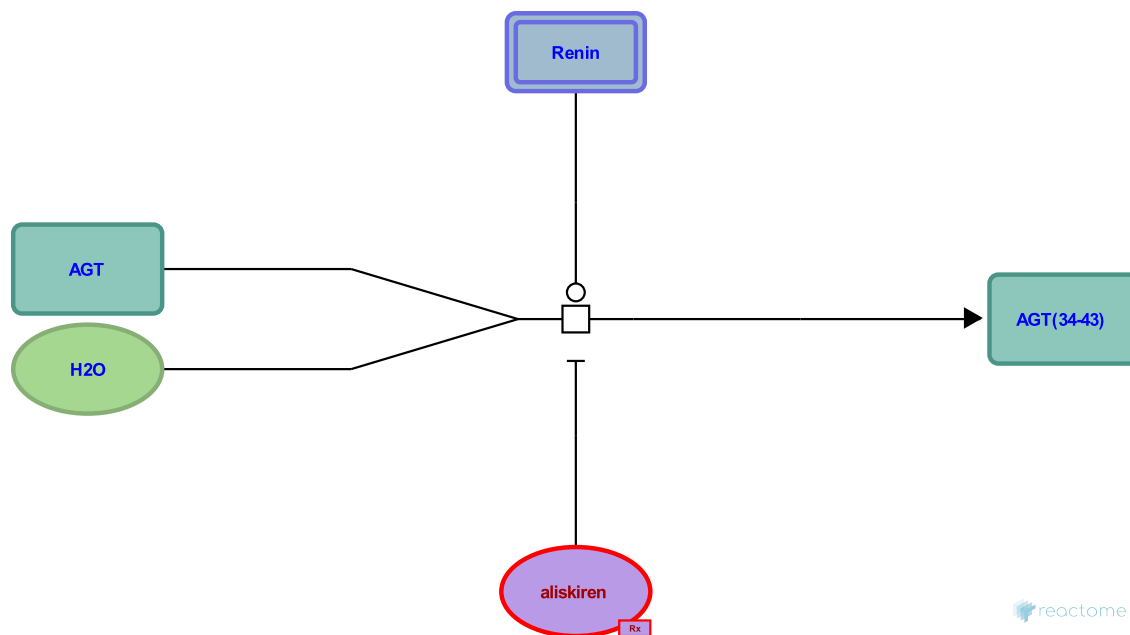

This event has been computationally inferred from an event that has been demonstrated in another species.

The inference is based on the homology mapping from PANTHER. Briefly, reactions for which all involved PhysicalEntities (in input, output and catalyst) have a mapped orthologue/paralogue (for complexes at least 75% of components must have a mapping) are inferred to the other species. High level events are also inferred for these events to allow for easier navigation.

[More details and caveats of the event inference in Reactome.](#) For details on PANTHER see also: <http://www.pantherdb.org/about.jsp>

Followed by: [MME:Zn²⁺ \(Nepriylsin\) hydrolyses AGT\(34-43\)](#), [Cathepsin G hydrolyzes Angiotensin-\(1-10\) to Angiotensin-\(1-8\)](#), [Cathepsin Z \(Cathepsin X\) hydrolyzes Angiotensin-\(1-10\) to Angiotensin-\(1-8\)](#), [Chymase hydrolyzes Angiotensin-\(1-10\) to Angiotensin-\(1-8\)](#), [ACE2\(18-805\):Zn²⁺ hydrolyzes Angiotensin-\(1-10\) to Angiotensin-\(1-9\)](#), [ACE:Zn²⁺ hydrolyzes Angiotensin-\(1-10\) to Angiotensin-\(1-8\)](#), [Secreted ACE:Zn²⁺ hydrolyzes Angiotensin-\(1-10\) to Angiotensin-\(1-8\)](#)

Renin:Prorenin Receptor hydrolyzes Angiotensinogen to Angiotensin-(1-10) ↗

Location: Metabolism of Angiotensinogen to Angiotensins

Stable identifier: R-GGA-2022403

Type: transition

Compartments: plasma membrane, extracellular region

Inferred from: Renin:Prorenin Receptor hydrolyzes Angiotensinogen to Angiotensin-(1-10) (Homo sapiens)

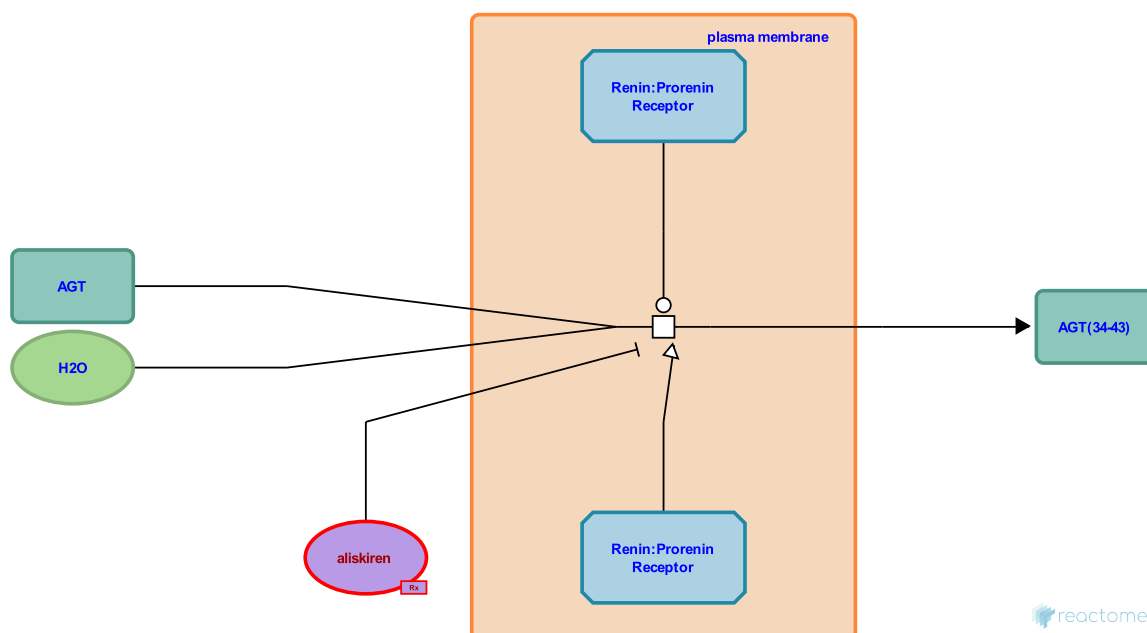

This event has been computationally inferred from an event that has been demonstrated in another species.

The inference is based on the homology mapping from PANTHER. Briefly, reactions for which all involved PhysicalEntities (in input, output and catalyst) have a mapped orthologue/paralogue (for complexes at least 75% of components must have a mapping) are inferred to the other species. High level events are also inferred for these events to allow for easier navigation.

[More details and caveats of the event inference in Reactome.](http://www.pantherdb.org/about.jsp) For details on PANTHER see also: <http://www.pantherdb.org/about.jsp>

Followed by: MME:Zn²⁺ (Neprilysin) hydrolyses AGT(34-43), Cathepsin G hydrolyzes Angiotensin-(1-10) to Angiotensin-(1-8), Cathepsin Z (Cathepsin X) hydrolyzes Angiotensin-(1-10) to Angiotensin-(1-8), Chymase hydrolyzes Angiotensin-(1-10) to Angiotensin-(1-8), ACE2(18-805):Zn²⁺ hydrolyzes Angiotensin-(1-10) to Angiotensin-(1-9), ACE:Zn²⁺ hydrolyzes Angiotensin-(1-10) to Angiotensin-(1-8), Secreted ACE:Zn²⁺ hydrolyzes Angiotensin-(1-10) to Angiotensin-(1-8)

Prorenin:Prorenin Receptor hydrolyzes Angiotensinogen to Angiotensin-(1-10) ↗

Location: [Metabolism of Angiotensinogen to Angiotensins](#)

Stable identifier: R-GGA-2065357

Type: transition

Compartments: plasma membrane, extracellular region

Inferred from: [Prorenin:Prorenin Receptor hydrolyzes Angiotensinogen to Angiotensin-\(1-10\) \(Homo sapiens\)](#)

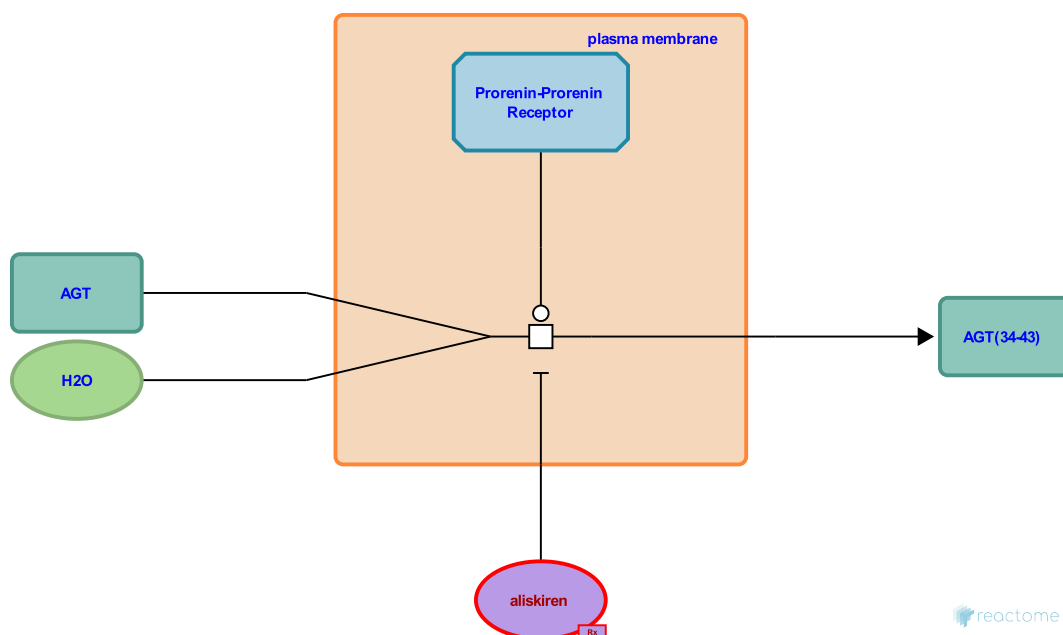

This event has been computationally inferred from an event that has been demonstrated in another species.

The inference is based on the homology mapping from PANTHER. Briefly, reactions for which all involved PhysicalEntities (in input, output and catalyst) have a mapped orthologue/paralogue (for complexes at least 75% of components must have a mapping) are inferred to the other species. High level events are also inferred for these events to allow for easier navigation.

[More details and caveats of the event inference in Reactome.](#) For details on PANTHER see also: <http://www.pantherdb.org/about.jsp>

Followed by: [MME:Zn²⁺ \(Nepriylsin\) hydrolyses AGT\(34-43\)](#), [Cathepsin G hydrolyzes Angiotensin-\(1-10\) to Angiotensin-\(1-8\)](#), [Cathepsin Z \(Cathepsin X\) hydrolyzes Angiotensin-\(1-10\) to Angiotensin-\(1-8\)](#), [Chymase hydrolyzes Angiotensin-\(1-10\) to Angiotensin-\(1-8\)](#), [ACE2\(18-805\):Zn²⁺ hydrolyzes Angiotensin-\(1-10\) to Angiotensin-\(1-9\)](#), [ACE:Zn²⁺ hydrolyzes Angiotensin-\(1-10\) to Angiotensin-\(1-8\)](#), [Secreted ACE:Zn²⁺ hydrolyzes Angiotensin-\(1-10\) to Angiotensin-\(1-8\)](#)

ACE:Zn²⁺ hydrolyzes Angiotensin-(1-10) to Angiotensin-(1-8) ↗

Location: [Metabolism of Angiotensinogen to Angiotensins](#)

Stable identifier: R-GGA-2022405

Type: transition

Compartments: plasma membrane, extracellular region

Inferred from: [ACE:Zn²⁺ hydrolyzes Angiotensin-\(1-10\) to Angiotensin-\(1-8\) \(Homo sapiens\)](#)

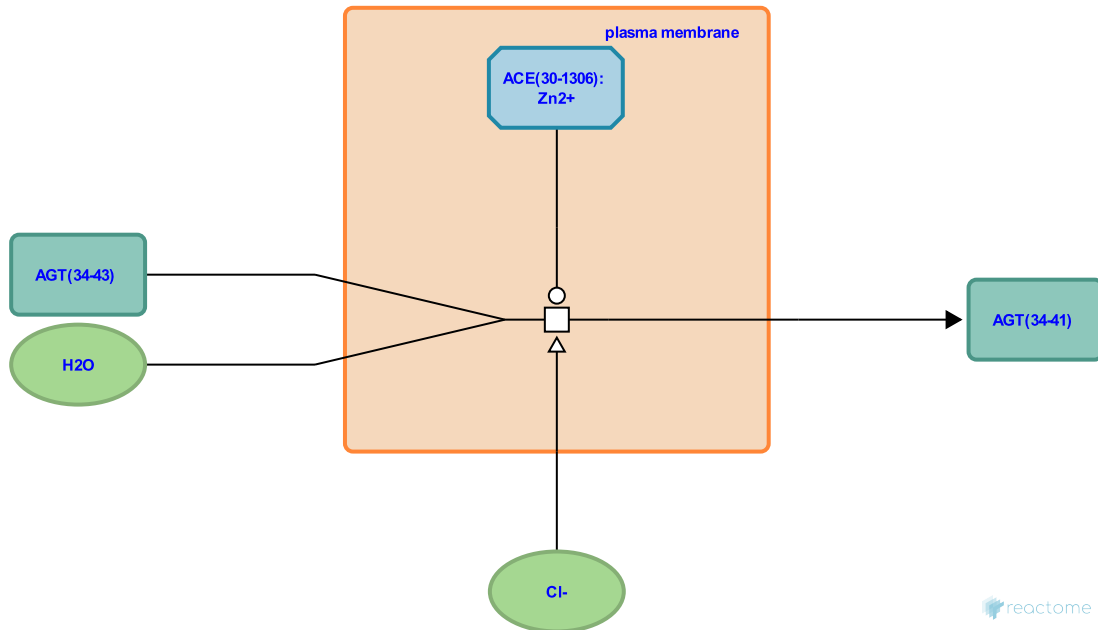

This event has been computationally inferred from an event that has been demonstrated in another species.

The inference is based on the homology mapping from PANTHER. Briefly, reactions for which all involved PhysicalEntities (in input, output and catalyst) have a mapped orthologue/paralogue (for complexes at least 75% of components must have a mapping) are inferred to the other species. High level events are also inferred for these events to allow for easier navigation.

[More details and caveats of the event inference in Reactome.](#) For details on PANTHER see also: <http://www.pantherdb.org/about.jsp>

Preceded by: [Renin:Prorenin Receptor hydrolyzes Angiotensinogen to Angiotensin-\(1-10\)](#), [Prorenin:Prorenin Receptor hydrolyzes Angiotensinogen to Angiotensin-\(1-10\)](#), [Renin hydrolyzes Angiotensinogen to Angiotensin-\(1-10\)](#)

Followed by: [ACE2\(18-805\):Zn²⁺ hydrolyzes Angiotensin-\(1-8\) to Angiotensin-\(1-7\)](#), [ENPEP:Zn²⁺ hydrolyzes Angiotensin-\(1-8\) to Angiotensin-\(2-8\)](#)

Secreted ACE:Zn²⁺ hydrolyzes Angiotensin-(1-10) to Angiotensin-(1-8) ↗

Location: [Metabolism of Angiotensinogen to Angiotensins](#)

Stable identifier: R-GGA-2065355

Type: transition

Compartments: extracellular region

Inferred from: [Secreted ACE:Zn²⁺ hydrolyzes Angiotensin-\(1-10\) to Angiotensin-\(1-8\) \(Homo sapiens\)](#)

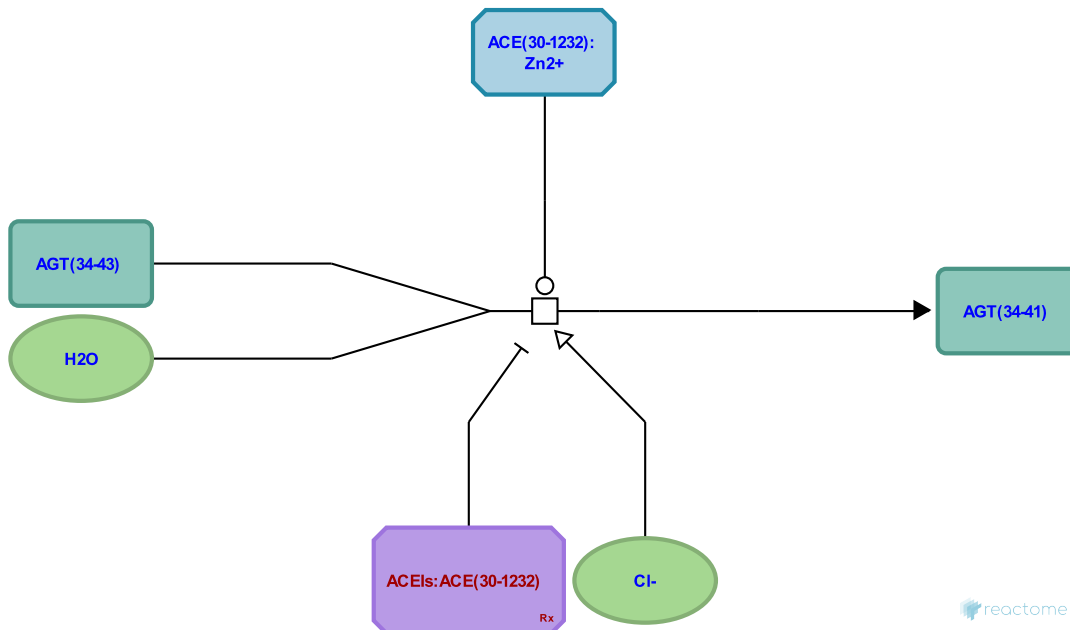

This event has been computationally inferred from an event that has been demonstrated in another species.

The inference is based on the homology mapping from PANTHER. Briefly, reactions for which all involved PhysicalEntities (in input, output and catalyst) have a mapped orthologue/paralogue (for complexes at least 75% of components must have a mapping) are inferred to the other species. High level events are also inferred for these events to allow for easier navigation.

[More details and caveats of the event inference in Reactome.](#) For details on PANTHER see also: <http://www.pantherdb.org/about.jsp>

Preceded by: [Renin:Prorenin Receptor hydrolyzes Angiotensinogen to Angiotensin-\(1-10\)](#), [Prorenin:Prorenin Receptor hydrolyzes Angiotensinogen to Angiotensin-\(1-10\)](#), [Renin hydrolyzes Angiotensinogen to Angiotensin-\(1-10\)](#)

Followed by: [ACE2\(18-805\):Zn²⁺ hydrolyzes Angiotensin-\(1-8\) to Angiotensin-\(1-7\)](#), [ENPEP:Zn²⁺ hydrolyzes Angiotensin-\(1-8\) to Angiotensin-\(2-8\)](#)

Chymase hydrolyzes Angiotensin-(1-10) to Angiotensin-(1-8) ↗

Location: [Metabolism of Angiotensinogen to Angiotensins](#)

Stable identifier: R-GGA-2022383

Type: transition

Compartments: extracellular region

Inferred from: [Chymase hydrolyzes Angiotensin-\(1-10\) to Angiotensin-\(1-8\) \(Homo sapiens\)](#)

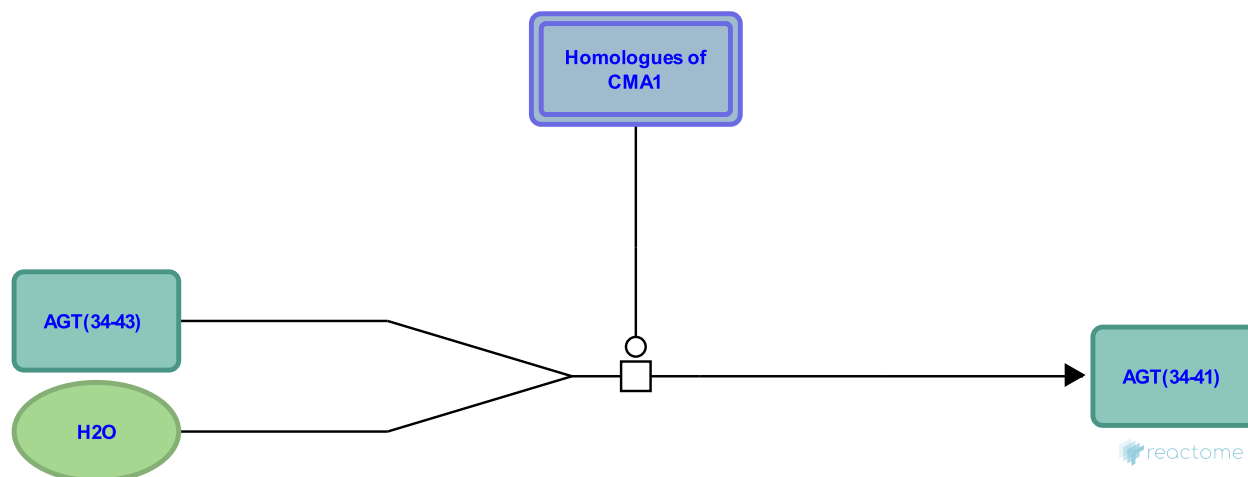

This event has been computationally inferred from an event that has been demonstrated in another species.

The inference is based on the homology mapping from PANTHER. Briefly, reactions for which all involved PhysicalEntities (in input, output and catalyst) have a mapped orthologue/paralogue (for complexes at least 75% of components must have a mapping) are inferred to the other species. High level events are also inferred for these events to allow for easier navigation.

[More details and caveats of the event inference in Reactome.](#) For details on PANTHER see also: <http://www.pantherdb.org/about.jsp>

Preceded by: [Renin:Prorenin Receptor hydrolyzes Angiotensinogen to Angiotensin-\(1-10\)](#), [Prorenin:Prorenin Receptor hydrolyzes Angiotensinogen to Angiotensin-\(1-10\)](#), [Renin hydrolyzes Angiotensinogen to Angiotensin-\(1-10\)](#)

Followed by: [ACE2\(18-805\):Zn²⁺ hydrolyzes Angiotensin-\(1-8\) to Angiotensin-\(1-7\)](#), [ENPEP:Zn²⁺ hydrolyzes Angiotensin-\(1-8\) to Angiotensin-\(2-8\)](#)

Cathepsin G hydrolyzes Angiotensin-(1-10) to Angiotensin-(1-8) ↗

Location: [Metabolism of Angiotensinogen to Angiotensins](#)

Stable identifier: R-GGA-2022411

Type: transition

Compartments: plasma membrane, extracellular region

Inferred from: [Cathepsin G hydrolyzes Angiotensin-\(1-10\) to Angiotensin-\(1-8\) \(Homo sapiens\)](#)

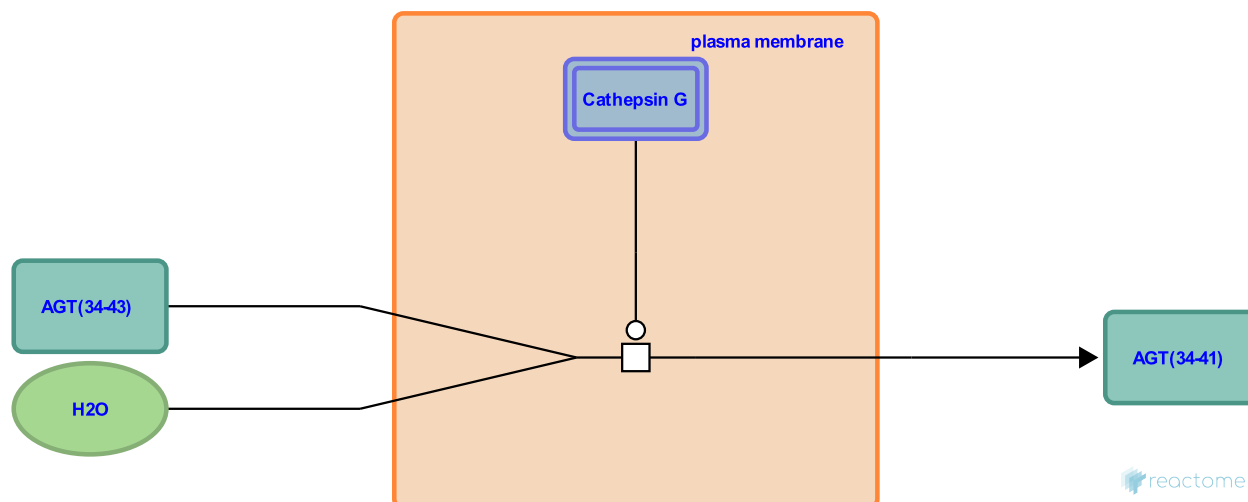

This event has been computationally inferred from an event that has been demonstrated in another species.

The inference is based on the homology mapping from PANTHER. Briefly, reactions for which all involved PhysicalEntities (in input, output and catalyst) have a mapped orthologue/paralogue (for complexes at least 75% of components must have a mapping) are inferred to the other species. High level events are also inferred for these events to allow for easier navigation.

[More details and caveats of the event inference in Reactome.](#) For details on PANTHER see also: <http://www.pantherdb.org/about.jsp>

Preceded by: [Renin:Prorenin Receptor hydrolyzes Angiotensinogen to Angiotensin-\(1-10\)](#), [Prorenin:Prorenin Receptor hydrolyzes Angiotensinogen to Angiotensin-\(1-10\)](#), [Renin hydrolyzes Angiotensinogen to Angiotensin-\(1-10\)](#)

Followed by: [ACE2\(18-805\):Zn²⁺ hydrolyzes Angiotensin-\(1-8\) to Angiotensin-\(1-7\)](#), [ENPEP:Zn²⁺ hydrolyzes Angiotensin-\(1-8\) to Angiotensin-\(2-8\)](#)

Cathepsin Z (Cathepsin X) hydrolyzes Angiotensin-(1-10) to Angiotensin-(1-8) ↗

Location: Metabolism of Angiotensinogen to Angiotensins

Stable identifier: R-GGA-2022381

Type: transition

Compartments: plasma membrane, extracellular region

Inferred from: Cathepsin Z (Cathepsin X) hydrolyzes Angiotensin-(1-10) to Angiotensin-(1-8) (Homo sapiens)

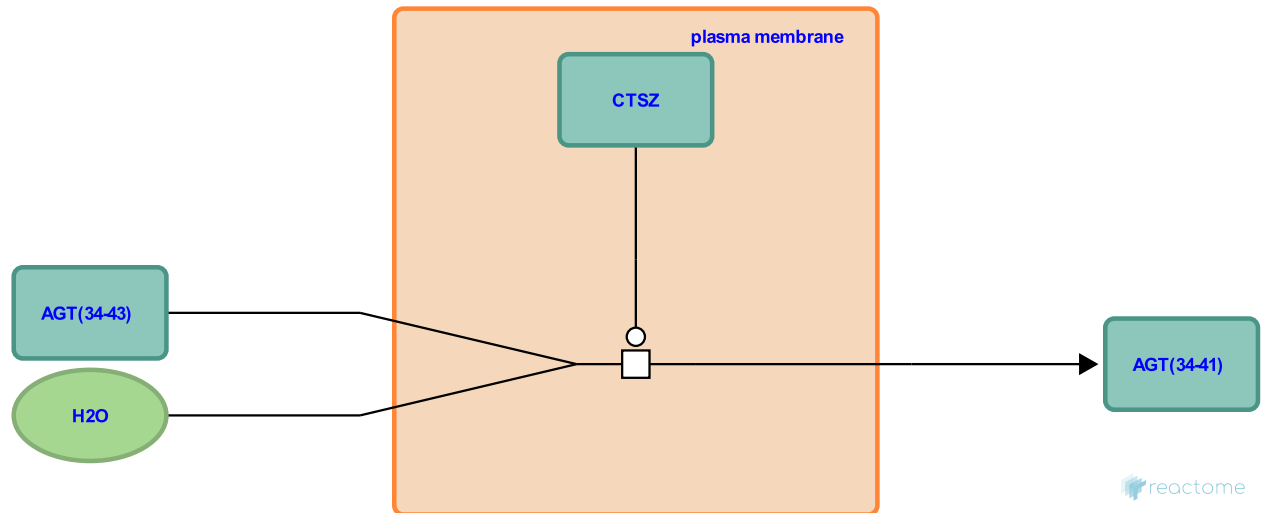

This event has been computationally inferred from an event that has been demonstrated in another species.

The inference is based on the homology mapping from PANTHER. Briefly, reactions for which all involved PhysicalEntities (in input, output and catalyst) have a mapped orthologue/paralogue (for complexes at least 75% of components must have a mapping) are inferred to the other species. High level events are also inferred for these events to allow for easier navigation.

[More details and caveats of the event inference in Reactome.](http://www.pantherdb.org/about.jsp) For details on PANTHER see also: <http://www.pantherdb.org/about.jsp>

Preceded by: Renin:Prorenin Receptor hydrolyzes Angiotensinogen to Angiotensin-(1-10), Prorenin:Prorenin Receptor hydrolyzes Angiotensinogen to Angiotensin-(1-10), Renin hydrolyzes Angiotensinogen to Angiotensin-(1-10)

Followed by: ACE2(18-805):Zn²⁺ hydrolyzes Angiotensin-(1-8) to Angiotensin-(1-7), ENPEP:Zn²⁺ hydrolyzes Angiotensin-(1-8) to Angiotensin-(2-8)

ACE2(18-805):Zn2+ hydrolyzes Angiotensin-(1-10) to Angiotensin-(1-9) ↗

Location: [Metabolism of Angiotensinogen to Angiotensins](#)

Stable identifier: R-GGA-2022378

Type: transition

Compartments: plasma membrane, extracellular region

Inferred from: [ACE2\(18-805\):Zn2+ hydrolyzes Angiotensin-\(1-10\) to Angiotensin-\(1-9\) \(Homo sapiens\)](#)

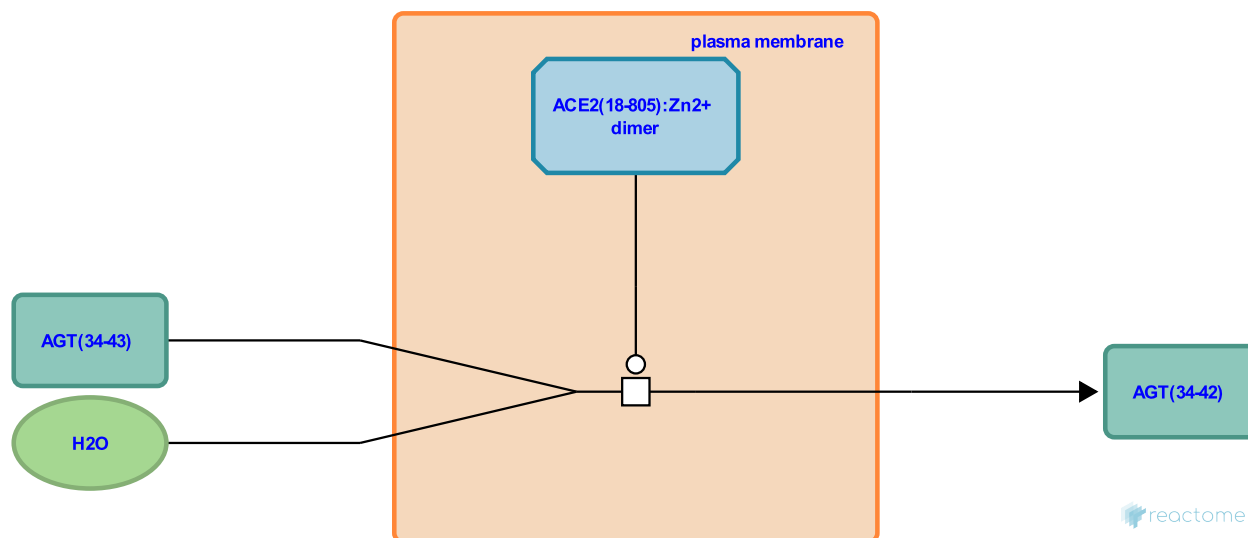

This event has been computationally inferred from an event that has been demonstrated in another species.

The inference is based on the homology mapping from PANTHER. Briefly, reactions for which all involved PhysicalEntities (in input, output and catalyst) have a mapped orthologue/paralogue (for complexes at least 75% of components must have a mapping) are inferred to the other species. High level events are also inferred for these events to allow for easier navigation.

[More details and caveats of the event inference in Reactome.](#) For details on PANTHER see also: <http://www.pantherdb.org/about.jsp>

Preceded by: [Renin:Prorenin Receptor hydrolyzes Angiotensinogen to Angiotensin-\(1-10\)](#), [Prorenin:Prorenin Receptor hydrolyzes Angiotensinogen to Angiotensin-\(1-10\)](#), [Renin hydrolyzes Angiotensinogen to Angiotensin-\(1-10\)](#)

Followed by: [MME:Zn2+ \(Nepriylisin\) hydrolyses AGT\(34-42\)](#), [ACE:Zn2+ hydrolyzes Angiotensin-\(1-9\) to Angiotensin-\(1-7\)](#)

ACE:Zn²⁺ hydrolyzes Angiotensin-(1-9) to Angiotensin-(1-7) ↗

Location: [Metabolism of Angiotensinogen to Angiotensins](#)

Stable identifier: R-GGA-2022398

Type: transition

Compartments: plasma membrane, extracellular region

Inferred from: [ACE:Zn²⁺ hydrolyzes Angiotensin-\(1-9\) to Angiotensin-\(1-7\) \(Homo sapiens\)](#)

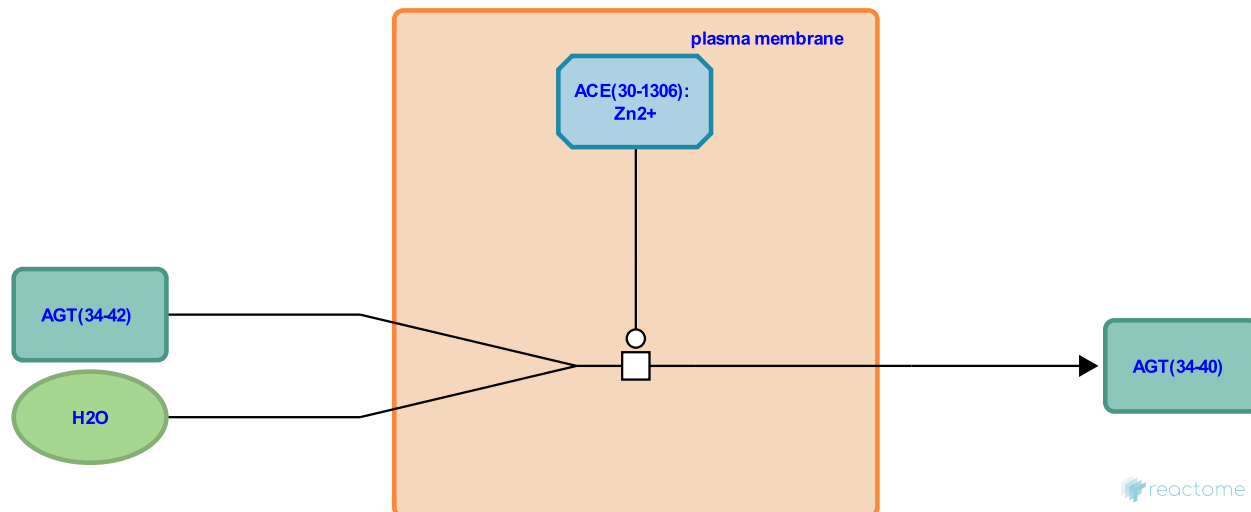

This event has been computationally inferred from an event that has been demonstrated in another species.

The inference is based on the homology mapping from PANTHER. Briefly, reactions for which all involved PhysicalEntities (in input, output and catalyst) have a mapped orthologue/paralogue (for complexes at least 75% of components must have a mapping) are inferred to the other species. High level events are also inferred for these events to allow for easier navigation.

[More details and caveats of the event inference in Reactome.](#) For details on PANTHER see also: <http://www.pantherdb.org/about.jsp>

Preceded by: [ACE2\(18-805\):Zn²⁺ hydrolyzes Angiotensin-\(1-10\) to Angiotensin-\(1-9\)](#)

MME:Zn²⁺ (Neprilysin) hydrolyses AGT(34-42) ↗

Location: [Metabolism of Angiotensinogen to Angiotensins](#)

Stable identifier: R-GGA-2022368

Type: transition

Compartments: plasma membrane, extracellular region

Inferred from: [MME:Zn²⁺ \(Neprilysin\) hydrolyses AGT\(34-42\) \(Homo sapiens\)](#)

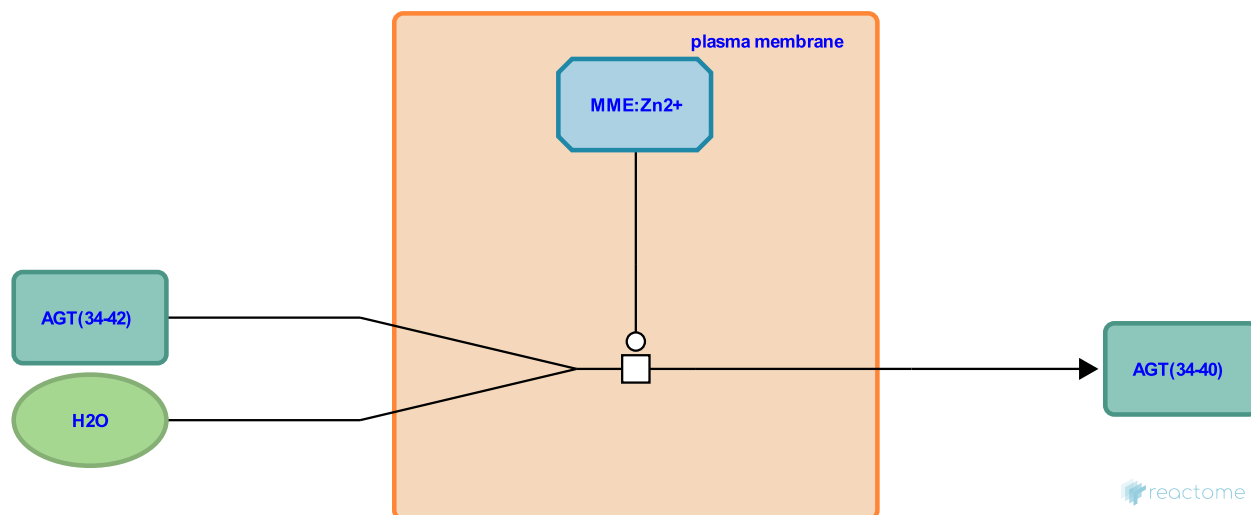

This event has been computationally inferred from an event that has been demonstrated in another species.

The inference is based on the homology mapping from PANTHER. Briefly, reactions for which all involved PhysicalEntities (in input, output and catalyst) have a mapped orthologue/paralogue (for complexes at least 75% of components must have a mapping) are inferred to the other species. High level events are also inferred for these events to allow for easier navigation.

[More details and caveats of the event inference in Reactome.](#) For details on PANTHER see also: <http://www.pantherdb.org/about.jsp>

Preceded by: [ACE2\(18-805\):Zn²⁺ hydrolyzes Angiotensin-\(1-10\) to Angiotensin-\(1-9\)](#)

MME:Zn²⁺ (Neprilysin) hydrolyses AGT(34-43) ↗

Location: [Metabolism of Angiotensinogen to Angiotensins](#)

Stable identifier: R-GGA-2022396

Type: transition

Compartments: plasma membrane, extracellular region

Inferred from: [MME:Zn²⁺ \(Neprilysin\) hydrolyses AGT\(34-43\) \(Homo sapiens\)](#)

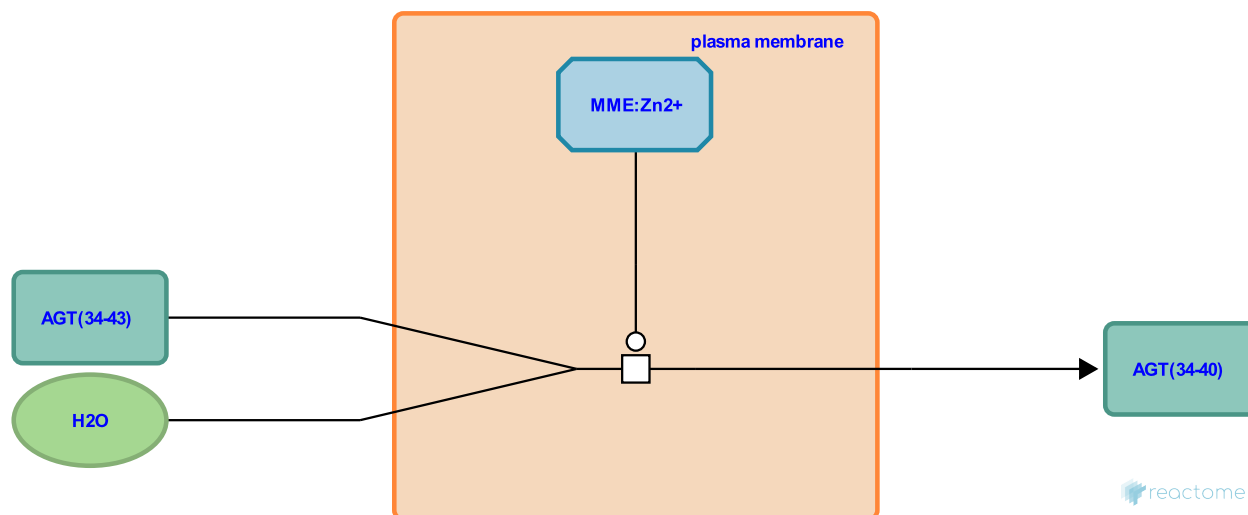

This event has been computationally inferred from an event that has been demonstrated in another species.

The inference is based on the homology mapping from PANTHER. Briefly, reactions for which all involved PhysicalEntities (in input, output and catalyst) have a mapped orthologue/paralogue (for complexes at least 75% of components must have a mapping) are inferred to the other species. High level events are also inferred for these events to allow for easier navigation.

[More details and caveats of the event inference in Reactome.](#) For details on PANTHER see also: <http://www.pantherdb.org/about.jsp>

Preceded by: [Renin:Prorenin Receptor hydrolyzes Angiotensinogen to Angiotensin-\(1-10\)](#), [Prorenin:Prorenin Receptor hydrolyzes Angiotensinogen to Angiotensin-\(1-10\)](#), [Renin hydrolyzes Angiotensinogen to Angiotensin-\(1-10\)](#)

ENPEP:Zn²⁺ hydrolyzes Angiotensin-(1-8) to Angiotensin-(2-8) ↗

Location: [Metabolism of Angiotensinogen to Angiotensins](#)

Stable identifier: R-GGA-2022399

Type: transition

Compartments: plasma membrane, extracellular region

Inferred from: [ENPEP:Zn²⁺ hydrolyzes Angiotensin-\(1-8\) to Angiotensin-\(2-8\)](#) (Homo sapiens)

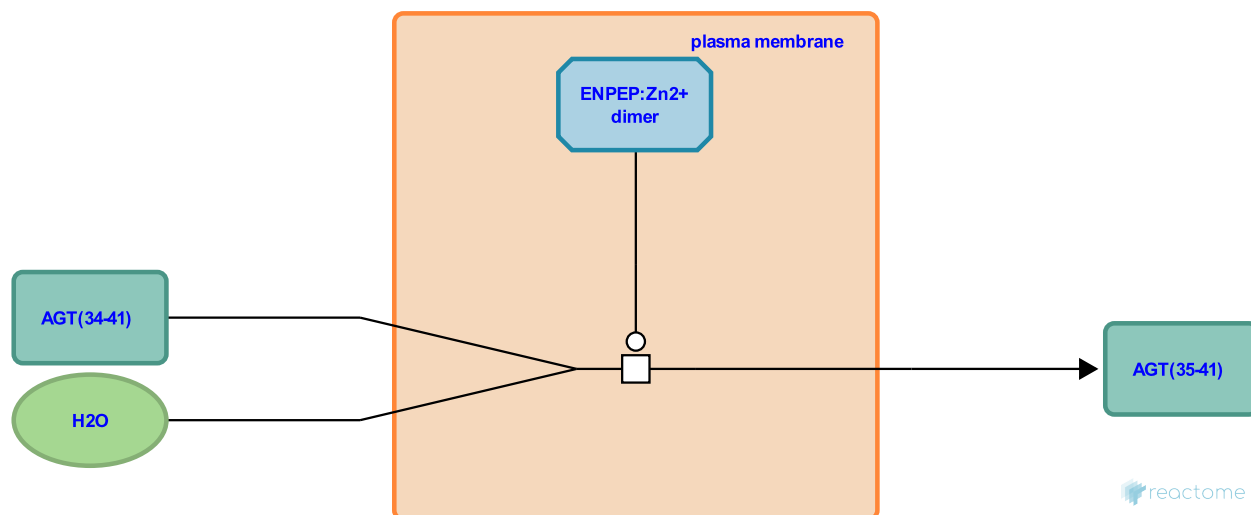

This event has been computationally inferred from an event that has been demonstrated in another species.

The inference is based on the homology mapping from PANTHER. Briefly, reactions for which all involved PhysicalEntities (in input, output and catalyst) have a mapped orthologue/paralogue (for complexes at least 75% of components must have a mapping) are inferred to the other species. High level events are also inferred for these events to allow for easier navigation.

[More details and caveats of the event inference in Reactome.](#) For details on PANTHER see also: <http://www.pantherdb.org/about.jsp>

Preceded by: [Secreted ACE:Zn²⁺ hydrolyzes Angiotensin-\(1-10\) to Angiotensin-\(1-8\)](#), [Cathepsin G hydrolyzes Angiotensin-\(1-10\) to Angiotensin-\(1-8\)](#), [Chymase hydrolyzes Angiotensin-\(1-10\) to Angiotensin-\(1-8\)](#), [Cathepsin Z \(Cathepsin X\) hydrolyzes Angiotensin-\(1-10\) to Angiotensin-\(1-8\)](#), [ACE:Zn²⁺ hydrolyzes Angiotensin-\(1-10\) to Angiotensin-\(1-8\)](#)

ACE2(18-805):Zn2+ hydrolyzes Angiotensin-(1-8) to Angiotensin-(1-7) ↗

Location: [Metabolism of Angiotensinogen to Angiotensins](#)

Stable identifier: R-GGA-2022379

Type: transition

Compartments: plasma membrane, extracellular region

Inferred from: [ACE2\(18-805\):Zn2+ hydrolyzes Angiotensin-\(1-8\) to Angiotensin-\(1-7\) \(Homo sapiens\)](#)

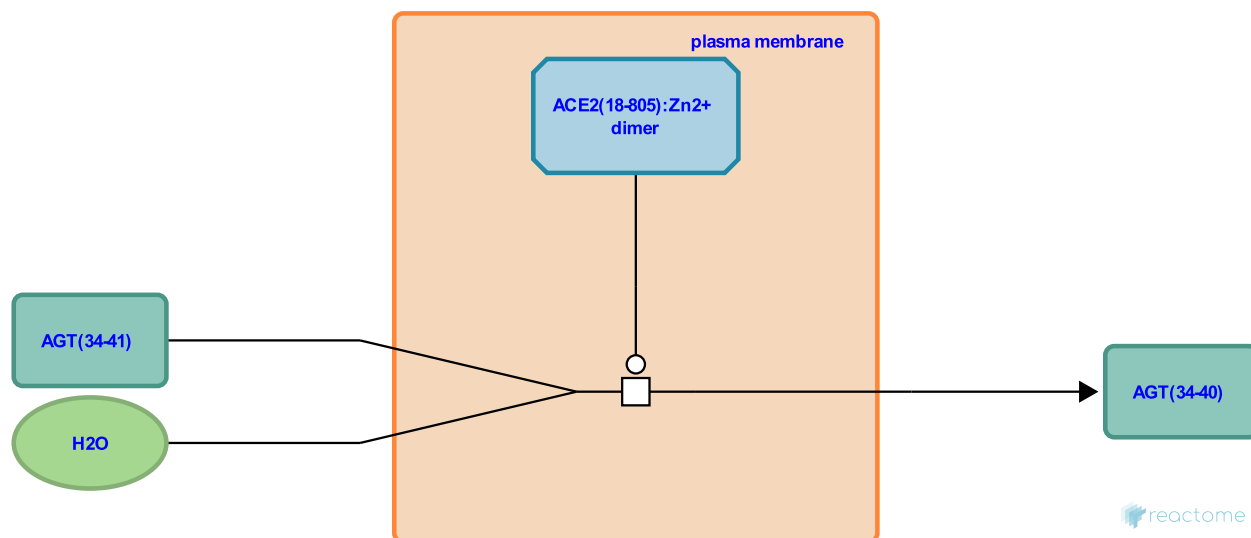

This event has been computationally inferred from an event that has been demonstrated in another species.

The inference is based on the homology mapping from PANTHER. Briefly, reactions for which all involved PhysicalEntities (in input, output and catalyst) have a mapped orthologue/paralogue (for complexes at least 75% of components must have a mapping) are inferred to the other species. High level events are also inferred for these events to allow for easier navigation.

[More details and caveats of the event inference in Reactome.](#) For details on PANTHER see also: <http://www.pantherdb.org/about.jsp>

Preceded by: [Secreted ACE:Zn2+ hydrolyzes Angiotensin-\(1-10\) to Angiotensin-\(1-8\)](#), [Cathepsin G hydrolyzes Angiotensin-\(1-10\) to Angiotensin-\(1-8\)](#), [Chymase hydrolyzes Angiotensin-\(1-10\) to Angiotensin-\(1-8\)](#), [Cathepsin Z \(Cathepsin X\) hydrolyzes Angiotensin-\(1-10\) to Angiotensin-\(1-8\)](#), [ACE:Zn2+ hydrolyzes Angiotensin-\(1-10\) to Angiotensin-\(1-8\)](#)

CES1 trimer hydrolyses ACEI pro-drugs to ACEIs ↗

Location: Metabolism of Angiotensinogen to Angiotensins

Stable identifier: R-GGA-9619024

Type: transition

Compartments: extracellular region

Inferred from: CES1 trimer hydrolyses ACEI pro-drugs to ACEIs (Homo sapiens)

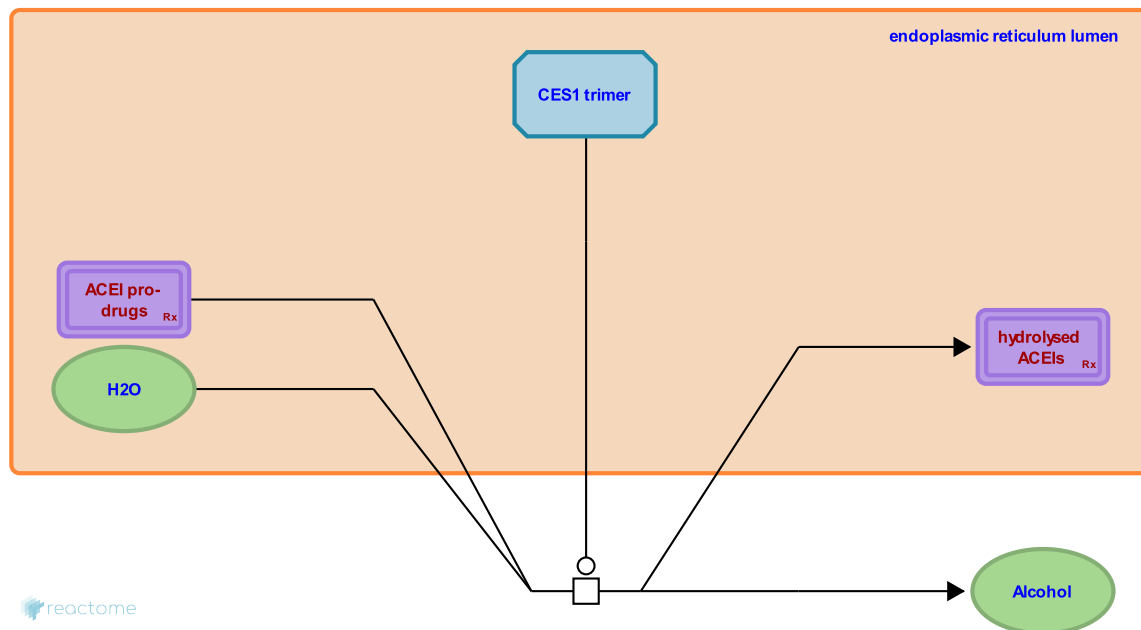

This event has been computationally inferred from an event that has been demonstrated in another species.

The inference is based on the homology mapping from PANTHER. Briefly, reactions for which all involved PhysicalEntities (in input, output and catalyst) have a mapped orthologue/paralogue (for complexes at least 75% of components must have a mapping) are inferred to the other species. High level events are also inferred for these events to allow for easier navigation.

[More details and caveats of the event inference in Reactome.](https://www.reactome.org) For details on PANTHER see also: <http://www.pantherdb.org/about.jsp>

ACEIs bind ACE ↗

Location: [Metabolism of Angiotensinogen to Angiotensins](#)

Stable identifier: R-GGA-9614933

Type: binding

Compartments: extracellular region

Inferred from: [ACEIs bind ACE \(Homo sapiens\)](#)

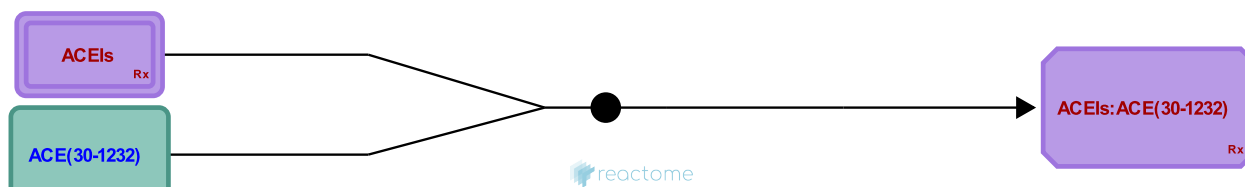

This event has been computationally inferred from an event that has been demonstrated in another species.

The inference is based on the homology mapping from PANTHER. Briefly, reactions for which all involved PhysicalEntities (in input, output and catalyst) have a mapped orthologue/paralogue (for complexes at least 75% of components must have a mapping) are inferred to the other species. High level events are also inferred for these events to allow for easier navigation.

[More details and caveats of the event inference in Reactome.](#) For details on PANTHER see also: <http://www.pantherdb.org/about.jsp>

Table of Contents

Introduction	1
☒ Metabolism of Angiotensinogen to Angiotensins	2
☞ Renin hydrolyzes Angiotensinogen to Angiotensin-(1-10)	3
☞ Renin:Prorenin Receptor hydrolyzes Angiotensinogen to Angiotensin-(1-10)	4
☞ Prorenin:Prorenin Receptor hydrolyzes Angiotensinogen to Angiotensin-(1-10)	5
☞ ACE:Zn ²⁺ hydrolyzes Angiotensin-(1-10) to Angiotensin-(1-8)	6
☞ Secreted ACE:Zn ²⁺ hydrolyzes Angiotensin-(1-10) to Angiotensin-(1-8)	7
☞ Chymase hydrolyzes Angiotensin-(1-10) to Angiotensin-(1-8)	8
☞ Cathepsin G hydrolyzes Angiotensin-(1-10) to Angiotensin-(1-8)	9
☞ Cathepsin Z (Cathepsin X) hydrolyzes Angiotensin-(1-10) to Angiotensin-(1-8)	10
☞ ACE2(18-805):Zn ²⁺ hydrolyzes Angiotensin-(1-10) to Angiotensin-(1-9)	11
☞ ACE:Zn ²⁺ hydrolyzes Angiotensin-(1-9) to Angiotensin-(1-7)	12
☞ MME:Zn ²⁺ (Nepilysin) hydrolyses AGT(34-42)	13
☞ MME:Zn ²⁺ (Nepilysin) hydrolyses AGT(34-43)	14
☞ ENPEP:Zn ²⁺ hydrolyzes Angiotensin-(1-8) to Angiotensin-(2-8)	15
☞ ACE2(18-805):Zn ²⁺ hydrolyzes Angiotensin-(1-8) to Angiotensin-(1-7)	16
☞ CES1trimer hydrolyses ACEI pro-drugs to ACEIs	17
☞ ACEIs bind ACE	18
Table of Contents	19