

Cellular hexose transport

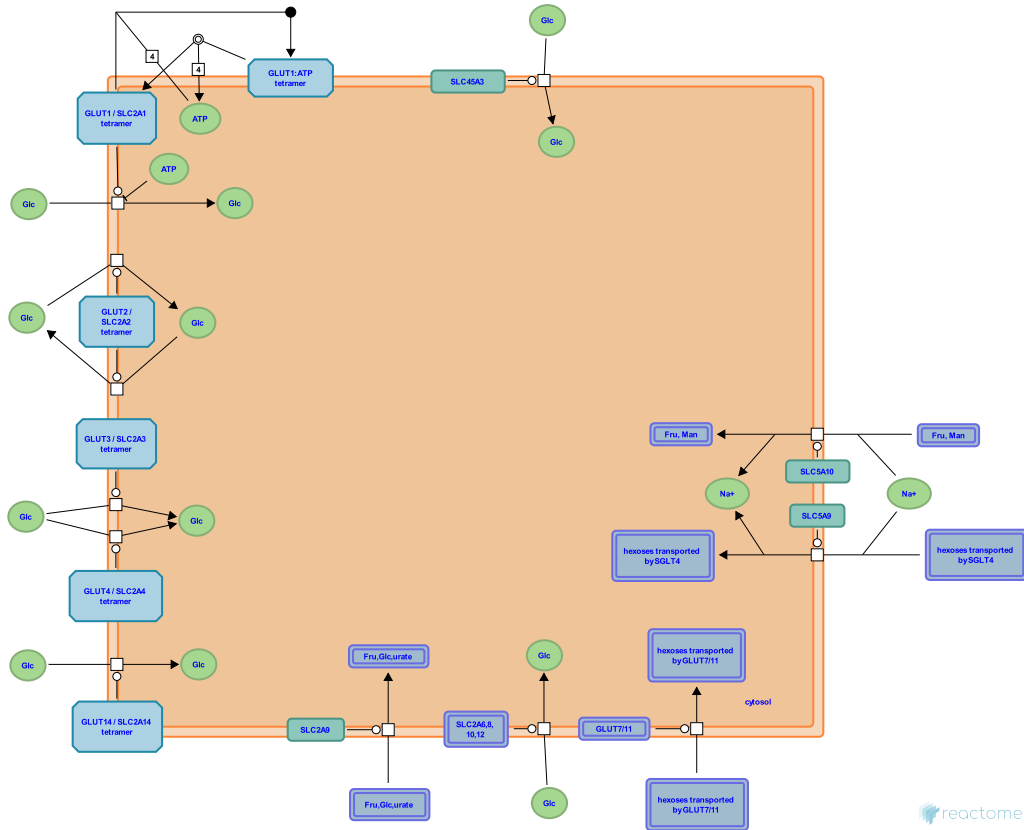

European Bioinformatics Institute, New York University Langone Medical Center, Ontario Institute for Cancer Research, Oregon Health and Science University.

The contents of this document may be freely copied and distributed in any media, provided the authors, plus the institutions, are credited, as stated under the terms of [Creative Commons Attribution 4.0 International \(CC BY 4.0\) License](https://creativecommons.org/licenses/by/4.0/). For more information see our [license](#).

This is just an excerpt of a full-length report for this pathway. To access the complete report, please download it at the [Reactome Textbook](#).

03/05/2024

Introduction

Reactome is open-source, open access, manually curated and peer-reviewed pathway database. Pathway annotations are authored by expert biologists, in collaboration with Reactome editorial staff and cross-referenced to many bioinformatics databases. A system of evidence tracking ensures that all assertions are backed up by the primary literature. Reactome is used by clinicians, geneticists, genomics researchers, and molecular biologists to interpret the results of high-throughput experimental studies, by bioinformaticians seeking to develop novel algorithms for mining knowledge from genomic studies, and by systems biologists building predictive models of normal and disease variant pathways.

The development of Reactome is supported by grants from the US National Institutes of Health (P41 HG003751), University of Toronto (CFREF Medicine by Design), European Union (EU STRP, EMI-CD), and the European Molecular Biology Laboratory (EBI Industry program).

Literature references

- Fabregat, A., Sidiropoulos, K., Viteri, G., Forner, O., Marin-Garcia, P., Arnau, V. et al. (2017). Reactome pathway analysis: a high-performance in-memory approach. *BMC bioinformatics*, 18, 142. [↗](#)
- Sidiropoulos, K., Viteri, G., Sevilla, C., Jupe, S., Webber, M., Orlic-Milacic, M. et al. (2017). Reactome enhanced pathway visualization. *Bioinformatics*, 33, 3461-3467. [↗](#)
- Fabregat, A., Jupe, S., Matthews, L., Sidiropoulos, K., Gillespie, M., Garapati, P. et al. (2018). The Reactome Pathway Knowledgebase. *Nucleic Acids Res*, 46, D649-D655. [↗](#)
- Fabregat, A., Korninger, F., Viteri, G., Sidiropoulos, K., Marin-Garcia, P., Ping, P. et al. (2018). Reactome graph database: Efficient access to complex pathway data. *PLoS computational biology*, 14, e1005968. [↗](#)

Reactome database release: 88

This document contains 1 pathway and 14 reactions ([see Table of Contents](#))

Cellular hexose transport ↗

Stable identifier: R-GGA-189200

Inferred from: Cellular hexose transport (Homo sapiens)

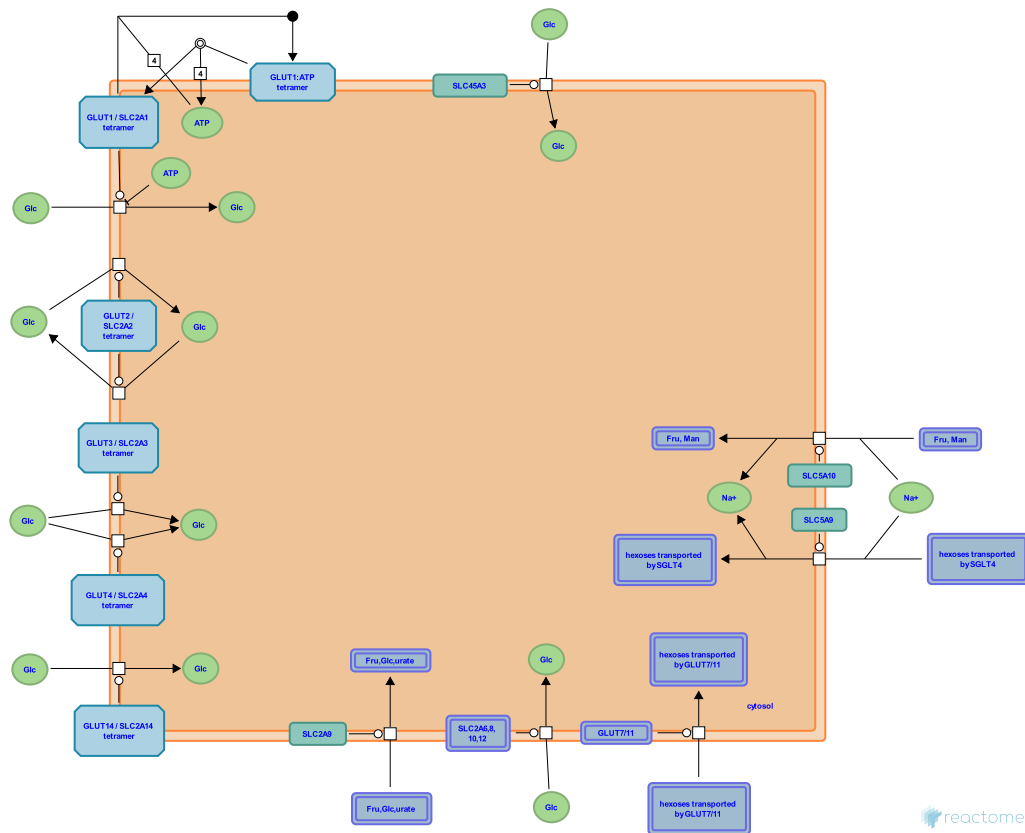

This event has been computationally inferred from an event that has been demonstrated in another species.

The inference is based on the homology mapping from PANTHER. Briefly, reactions for which all involved PhysicalEntities (in input, output and catalyst) have a mapped orthologue/paralogue (for complexes at least 75% of components must have a mapping) are inferred to the other species. High level events are also inferred for these events to allow for easier navigation.

[More details and caveats of the event inference in Reactome.](http://www.pantherdb.org/about.jsp) For details on PANTHER see also: <http://www.pantherdb.org/about.jsp>

GLUT1 (SLC2A1) tetramer transports Glc from extracellular region to cytosol ↗

Location: Cellular hexose transport

Stable identifier: R-GGA-5339524

Type: transition

Compartments: plasma membrane, extracellular region, cytosol

Inferred from: GLUT1 (SLC2A1) tetramer transports Glc from extracellular region to cytosol (Homo sapiens)

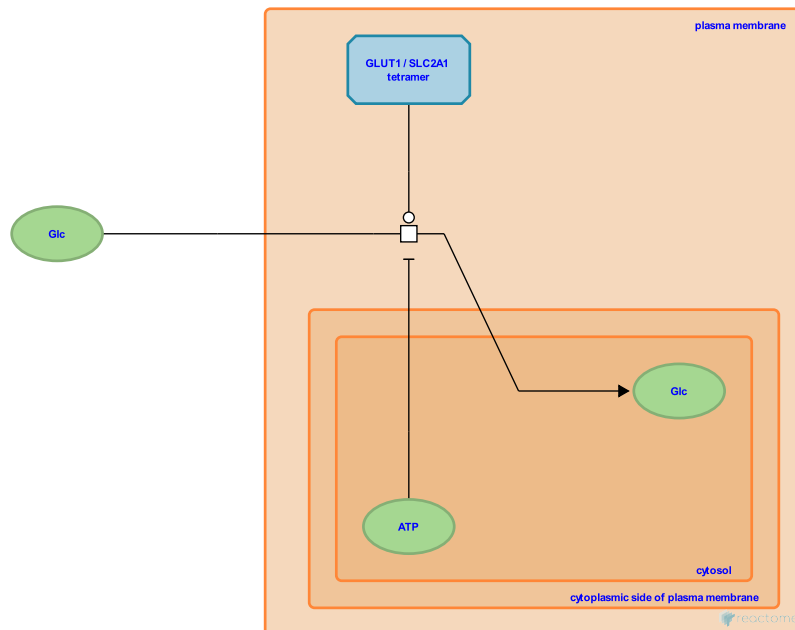

This event has been computationally inferred from an event that has been demonstrated in another species.

The inference is based on the homology mapping from PANTHER. Briefly, reactions for which all involved PhysicalEntities (in input, output and catalyst) have a mapped orthologue/paralogue (for complexes at least 75% of components must have a mapping) are inferred to the other species. High level events are also inferred for these events to allow for easier navigation.

[More details and caveats of the event inference in Reactome.](http://www.pantherdb.org/about.jsp) For details on PANTHER see also: <http://www.pantherdb.org/about.jsp>

Preceded by: GLUT1:ATP tetramer dissociates to GLUT1 tetramer and 4xATP

GLUT1 tetramer binds 4xATP ↗

Location: Cellular hexose transport

Stable identifier: R-GGA-450088

Type: binding

Compartments: plasma membrane, cytosol

Inferred from: GLUT1 tetramer binds 4xATP (Homo sapiens)

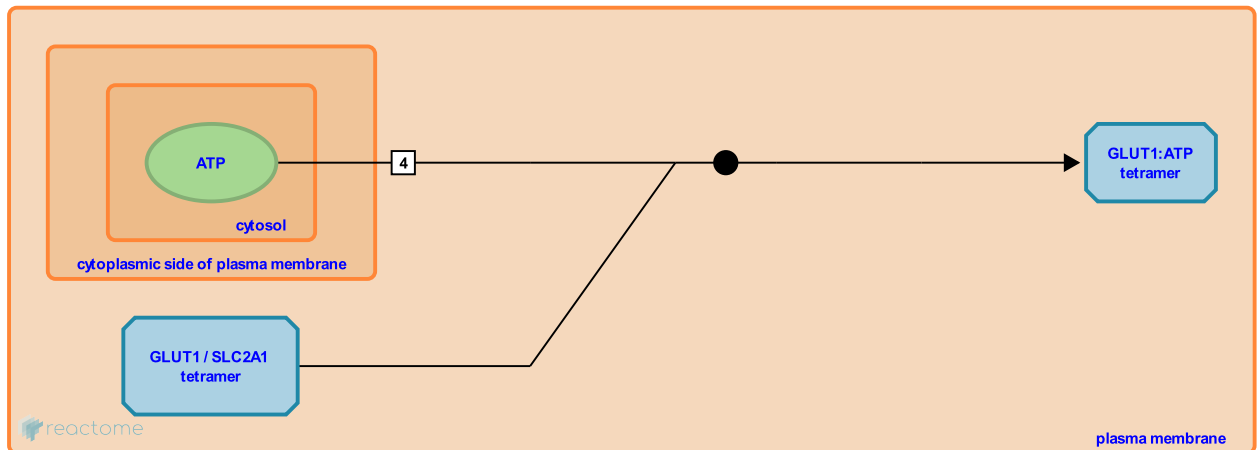

This event has been computationally inferred from an event that has been demonstrated in another species.

The inference is based on the homology mapping from PANTHER. Briefly, reactions for which all involved PhysicalEntities (in input, output and catalyst) have a mapped orthologue/paralogue (for complexes at least 75% of components must have a mapping) are inferred to the other species. High level events are also inferred for these events to allow for easier navigation.

[More details and caveats of the event inference in Reactome.](https://www.reactome.org) For details on PANTHER see also: <http://www.pantherdb.org/about.jsp>

GLUT1:ATP tetramer dissociates to GLUT1 tetramer and 4xATP ↗

Location: Cellular hexose transport

Stable identifier: R-GGA-450092

Type: dissociation

Compartments: plasma membrane, cytosol

Inferred from: GLUT1:ATP tetramer dissociates to GLUT1 tetramer and 4xATP (Homo sapiens)

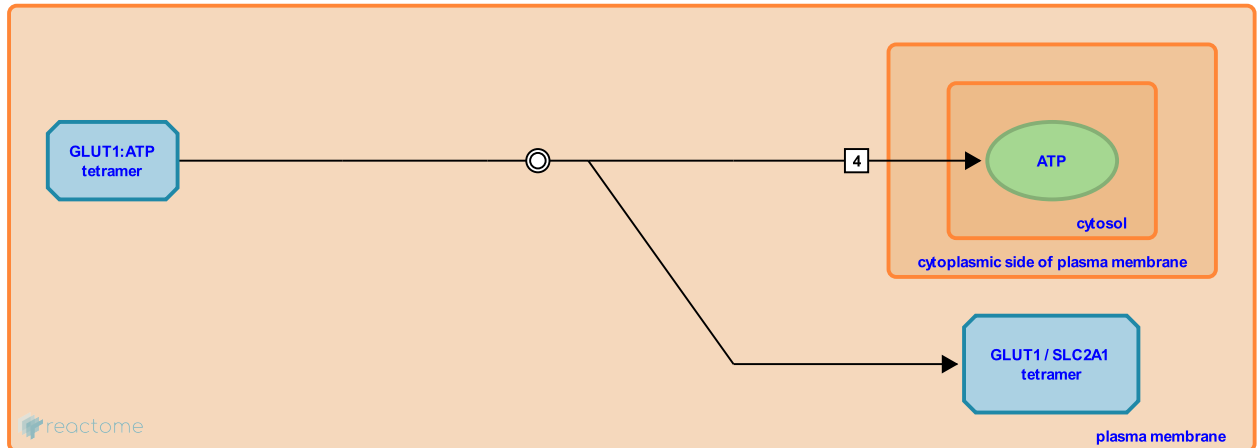

This event has been computationally inferred from an event that has been demonstrated in another species.

The inference is based on the homology mapping from PANTHER. Briefly, reactions for which all involved PhysicalEntities (in input, output and catalyst) have a mapped orthologue/paralogue (for complexes at least 75% of components must have a mapping) are inferred to the other species. High level events are also inferred for these events to allow for easier navigation.

[More details and caveats of the event inference in Reactome.](#) For details on PANTHER see also: <http://www.pantherdb.org/about.jsp>

Followed by: GLUT1 (SLC2A1) tetramer transports Glc from extracellular region to cytosol

GLUT2 (SLC2A2) tetramer transports Glc from extracellular region to cytosol ↗

Location: Cellular hexose transport

Stable identifier: R-GGA-8981574

Type: transition

Compartments: plasma membrane, extracellular region, cytosol

Inferred from: GLUT2 (SLC2A2) tetramer transports Glc from extracellular region to cytosol (Homo sapiens)

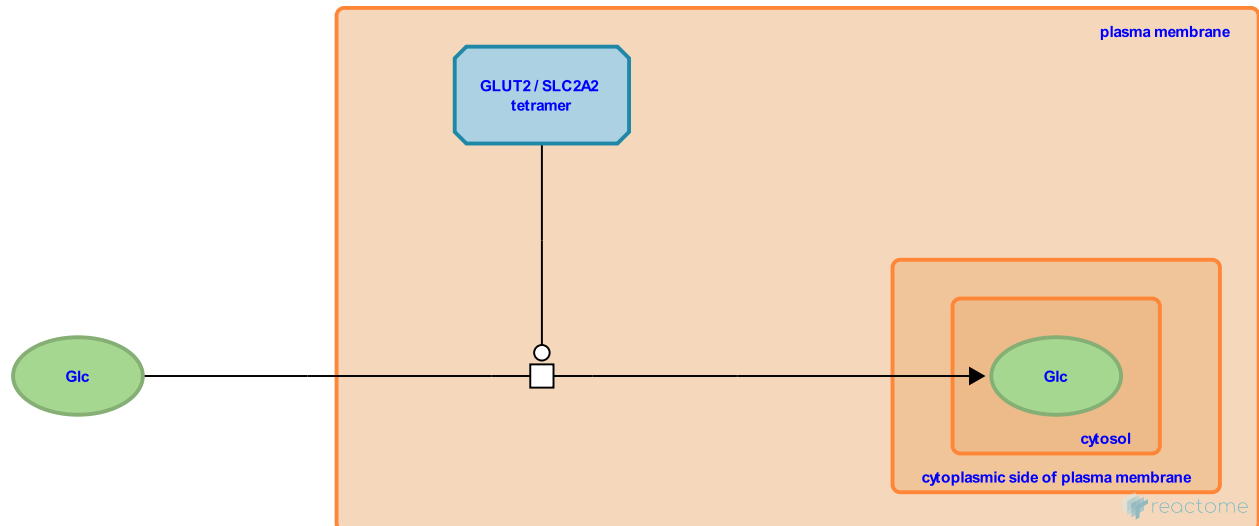

This event has been computationally inferred from an event that has been demonstrated in another species.

The inference is based on the homology mapping from PANTHER. Briefly, reactions for which all involved PhysicalEntities (in input, output and catalyst) have a mapped orthologue/paralogue (for complexes at least 75% of components must have a mapping) are inferred to the other species. High level events are also inferred for these events to allow for easier navigation.

[More details and caveats of the event inference in Reactome.](https://www.reactome.org) For details on PANTHER see also: <http://www.pantherdb.org/about.jsp>

GLUT2 (SLC2A2) transports Glc from cytosol to extracellular region ↗

Location: Cellular hexose transport

Stable identifier: R-GGA-450095

Type: transition

Compartments: plasma membrane, extracellular region, cytosol

Inferred from: GLUT2 (SLC2A2) transports Glc from cytosol to extracellular region (Homo sapiens)

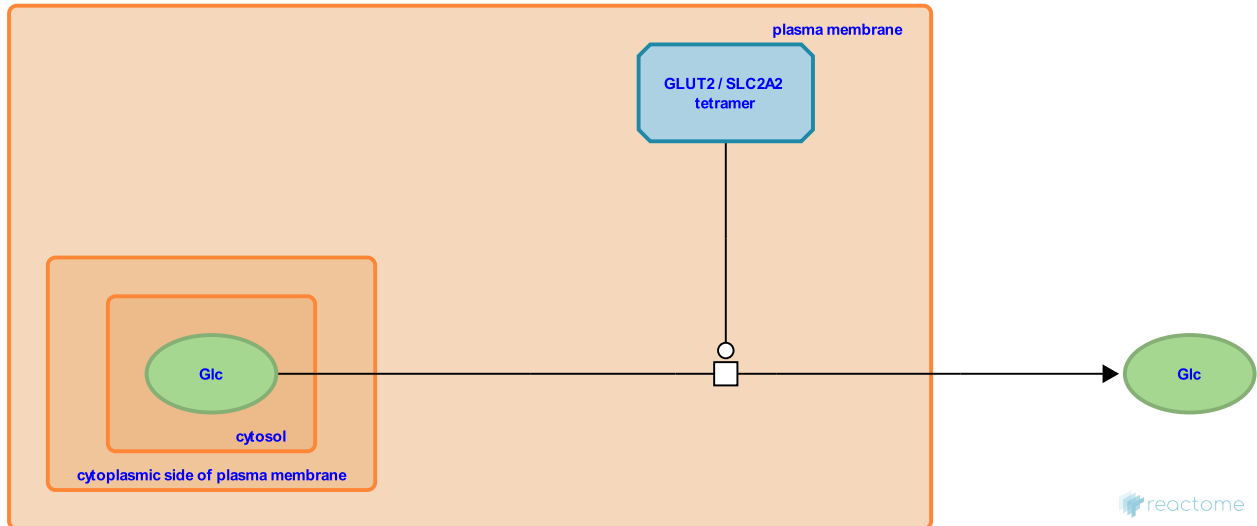

This event has been computationally inferred from an event that has been demonstrated in another species.

The inference is based on the homology mapping from PANTHER. Briefly, reactions for which all involved PhysicalEntities (in input, output and catalyst) have a mapped orthologue/paralogue (for complexes at least 75% of components must have a mapping) are inferred to the other species. High level events are also inferred for these events to allow for easier navigation.

[More details and caveats of the event inference in Reactome.](http://www.pantherdb.org/about.jsp) For details on PANTHER see also: <http://www.pantherdb.org/about.jsp>

GLUT3 (SLC2A3) tetramer transports Glc from extracellular region to cytosol ↗

Location: Cellular hexose transport

Stable identifier: R-GGA-8981564

Type: transition

Compartments: plasma membrane, extracellular region, cytosol

Inferred from: GLUT3 (SLC2A3) tetramer transports Glc from extracellular region to cytosol (Homo sapiens)

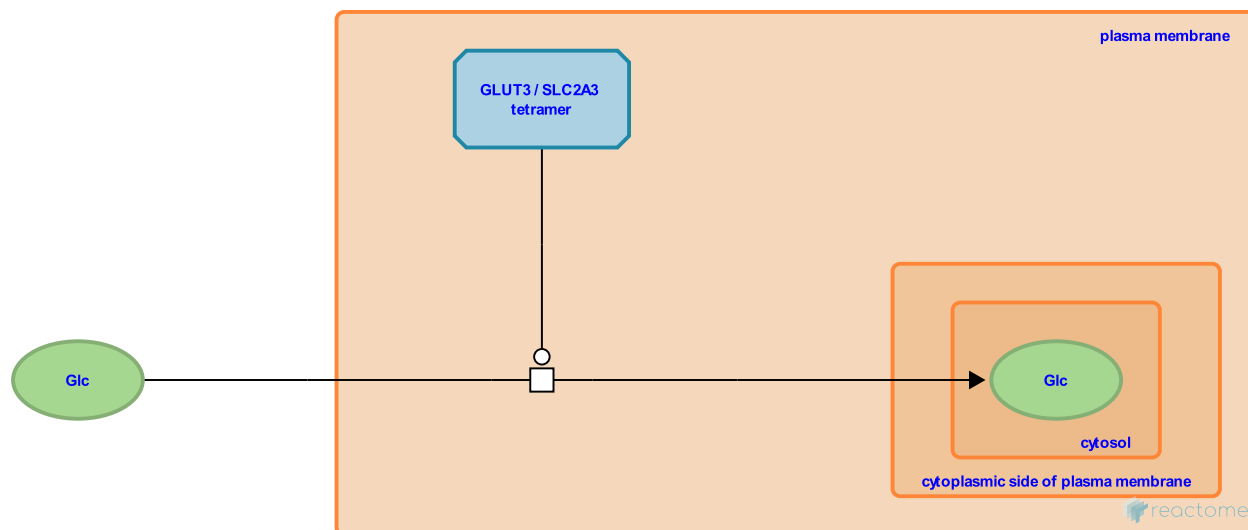

This event has been computationally inferred from an event that has been demonstrated in another species.

The inference is based on the homology mapping from PANTHER. Briefly, reactions for which all involved PhysicalEntities (in input, output and catalyst) have a mapped orthologue/paralogue (for complexes at least 75% of components must have a mapping) are inferred to the other species. High level events are also inferred for these events to allow for easier navigation.

[More details and caveats of the event inference in Reactome.](https://www.reactome.org) For details on PANTHER see also: <http://www.pantherdb.org/about.jsp>

GLUT4 (SLC2A4) tetramer transports Glc from extracellular region to cytosol ↗

Location: Cellular hexose transport

Stable identifier: R-GGA-8981570

Type: transition

Compartments: plasma membrane, extracellular region, cytosol

Inferred from: GLUT4 (SLC2A4) tetramer transports Glc from extracellular region to cytosol (Homo sapiens)

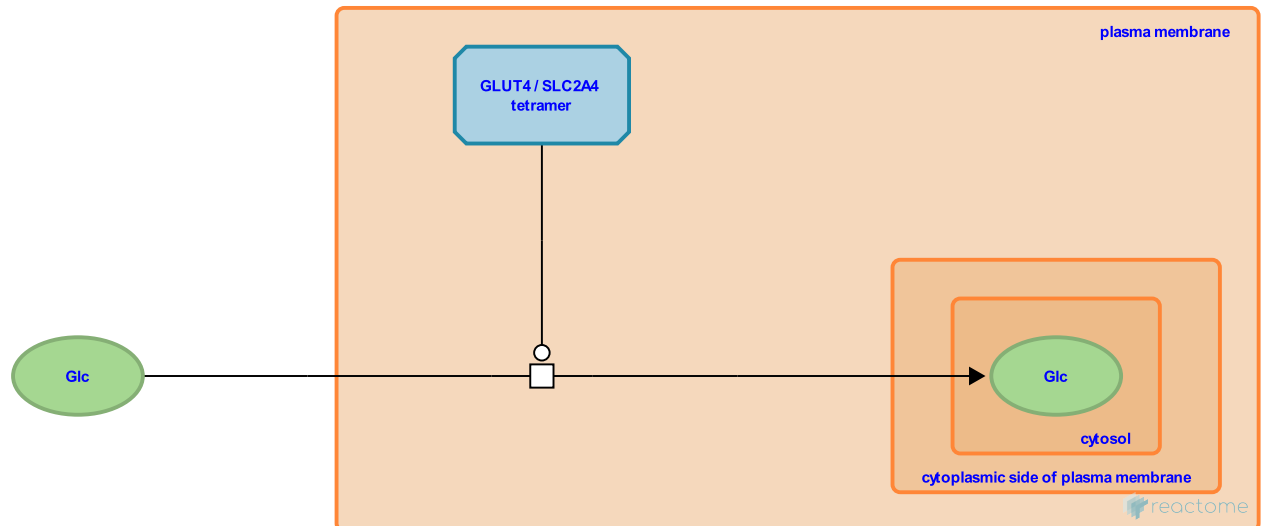

This event has been computationally inferred from an event that has been demonstrated in another species.

The inference is based on the homology mapping from PANTHER. Briefly, reactions for which all involved PhysicalEntities (in input, output and catalyst) have a mapped orthologue/paralogue (for complexes at least 75% of components must have a mapping) are inferred to the other species. High level events are also inferred for these events to allow for easier navigation.

[More details and caveats of the event inference in Reactome.](https://www.reactome.org) For details on PANTHER see also: <http://www.pantherdb.org/about.jsp>

SLC2A9 transports Fru, Glc, urate ↗

Location: Cellular hexose transport

Stable identifier: R-GGA-429036

Type: transition

Compartments: plasma membrane

Inferred from: SLC2A9 transports Fru, Glc, urate (Homo sapiens)

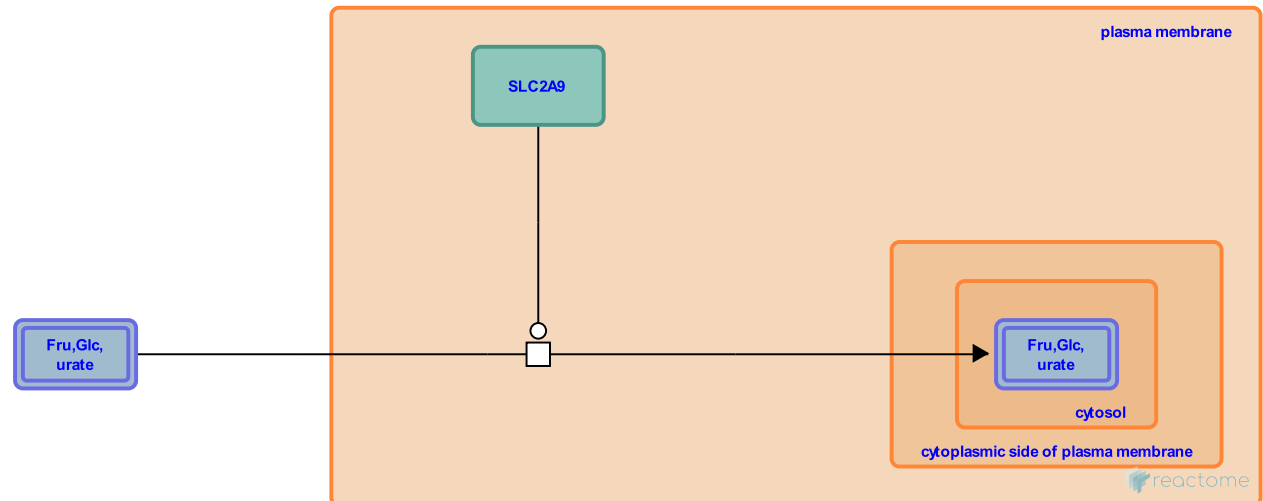

This event has been computationally inferred from an event that has been demonstrated in another species.

The inference is based on the homology mapping from PANTHER. Briefly, reactions for which all involved PhysicalEntities (in input, output and catalyst) have a mapped orthologue/paralogue (for complexes at least 75% of components must have a mapping) are inferred to the other species. High level events are also inferred for these events to allow for easier navigation.

[More details and caveats of the event inference in Reactome.](http://www.pantherdb.org/about.jsp) For details on PANTHER see also: <http://www.pantherdb.org/about.jsp>

SLC2A6,8,10,12 transport Glc from extracellular region to cytosol ↗

Location: Cellular hexose transport

Stable identifier: R-GGA-429094

Type: transition

Compartments: plasma membrane

Inferred from: SLC2A6,8,10,12 transport Glc from extracellular region to cytosol (Homo sapiens)

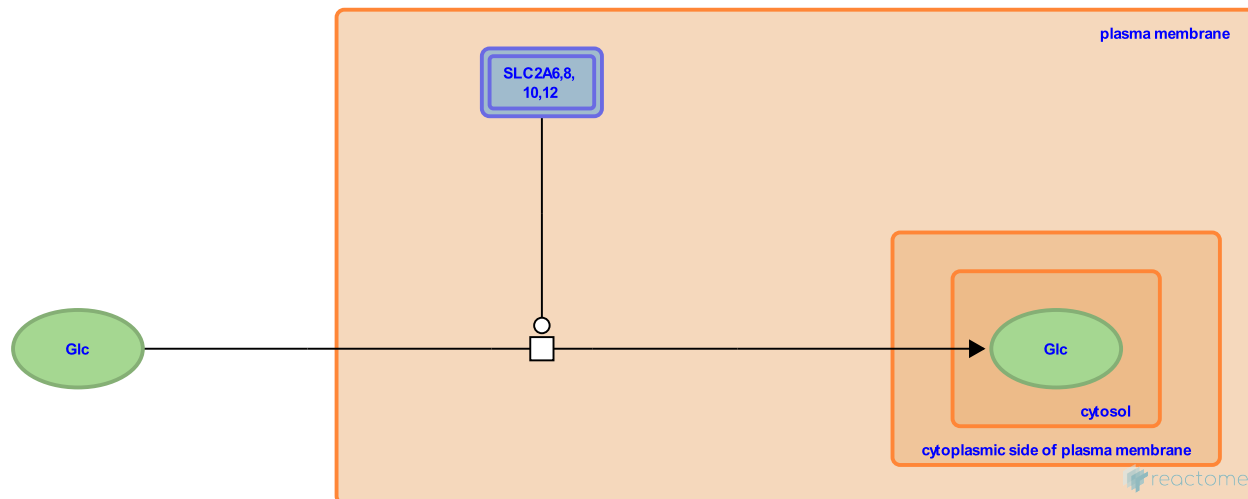

This event has been computationally inferred from an event that has been demonstrated in another species.

The inference is based on the homology mapping from PANTHER. Briefly, reactions for which all involved PhysicalEntities (in input, output and catalyst) have a mapped orthologue/paralogue (for complexes at least 75% of components must have a mapping) are inferred to the other species. High level events are also inferred for these events to allow for easier navigation.

[More details and caveats of the event inference in Reactome.](http://www.pantherdb.org/about.jsp) For details on PANTHER see also: <http://www.pantherdb.org/about.jsp>

GLUT7 and GLUT11 transport glucose and fructose ↗

Location: Cellular hexose transport

Stable identifier: R-GGA-428779

Type: transition

Compartments: plasma membrane

Inferred from: GLUT7 and GLUT11 transport glucose and fructose (Homo sapiens)

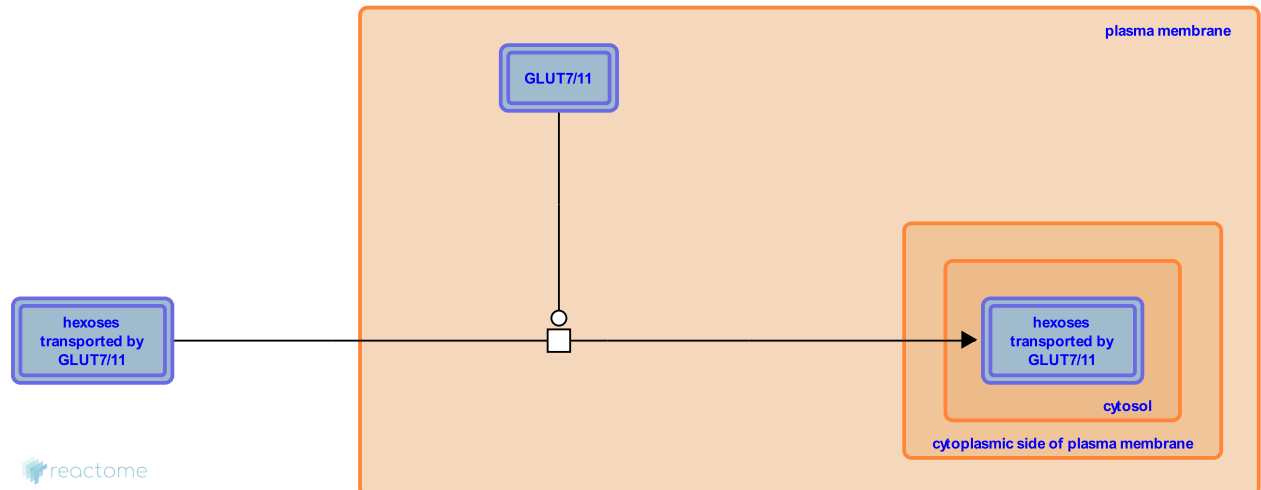

This event has been computationally inferred from an event that has been demonstrated in another species.

The inference is based on the homology mapping from PANTHER. Briefly, reactions for which all involved PhysicalEntities (in input, output and catalyst) have a mapped orthologue/paralogue (for complexes at least 75% of components must have a mapping) are inferred to the other species. High level events are also inferred for these events to allow for easier navigation.

[More details and caveats of the event inference in Reactome.](http://www.pantherdb.org/about.jsp) For details on PANTHER see also: <http://www.pantherdb.org/about.jsp>

GLUT14 (SLC2A14) tetramer transports Glc from extracellular region to cytosol ↗

Location: Cellular hexose transport

Stable identifier: R-GGA-8981553

Type: transition

Compartments: plasma membrane, extracellular region, cytosol

Inferred from: GLUT14 (SLC2A14) tetramer transports Glc from extracellular region to cytosol (Homo sapiens)

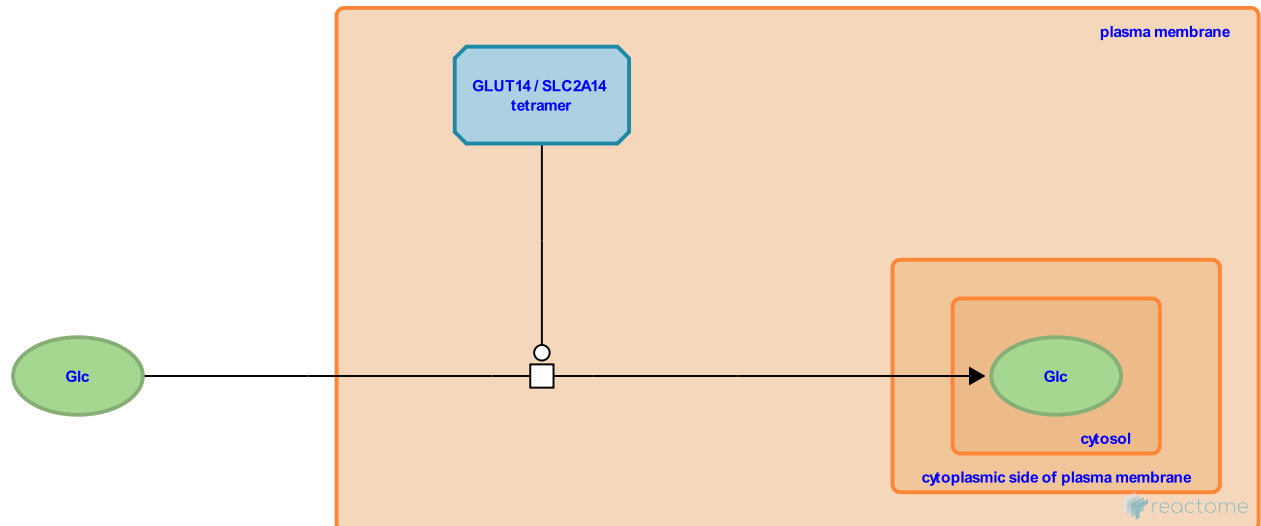

This event has been computationally inferred from an event that has been demonstrated in another species.

The inference is based on the homology mapping from PANTHER. Briefly, reactions for which all involved PhysicalEntities (in input, output and catalyst) have a mapped orthologue/paralogue (for complexes at least 75% of components must have a mapping) are inferred to the other species. High level events are also inferred for these events to allow for easier navigation.

[More details and caveats of the event inference in Reactome.](https://www.reactome.org) For details on PANTHER see also: <http://www.pantherdb.org/about.jsp>

SLC5A10 cotransports Na⁺ with Man, Fru from extracellular region to cytosol ↗

Location: Cellular hexose transport

Stable identifier: R-GGA-8876283

Type: transition

Compartments: plasma membrane, extracellular region, cytosol

Inferred from: SLC5A10 cotransports Na⁺ with Man, Fru from extracellular region to cytosol (Homo sapiens)

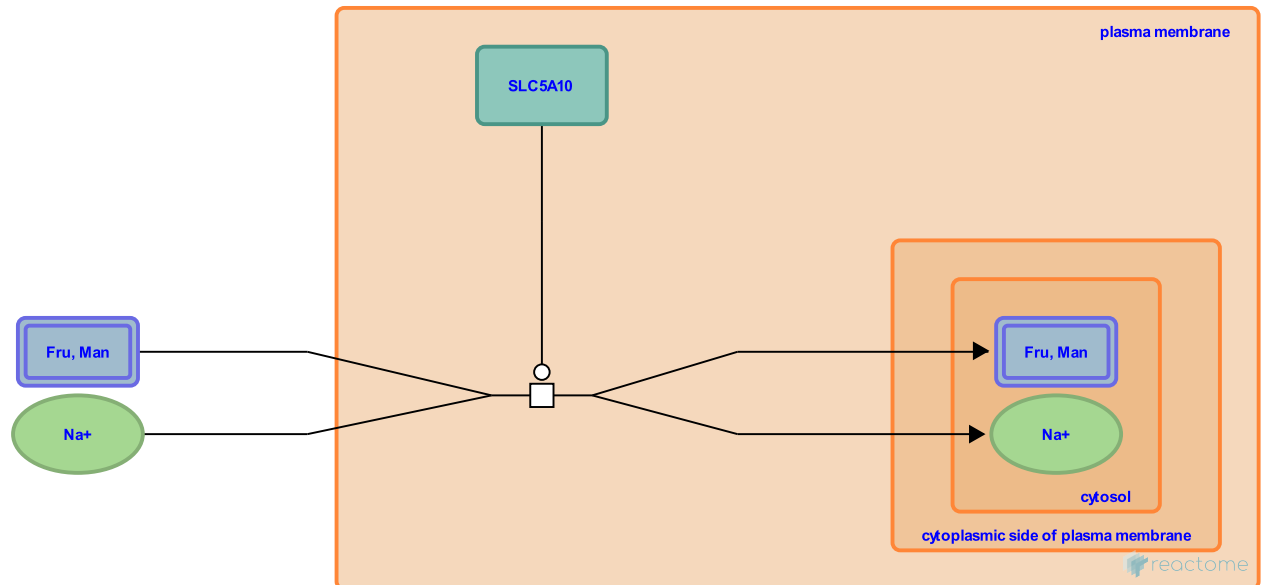

This event has been computationally inferred from an event that has been demonstrated in another species.

The inference is based on the homology mapping from PANTHER. Briefly, reactions for which all involved PhysicalEntities (in input, output and catalyst) have a mapped orthologue/paralogue (for complexes at least 75% of components must have a mapping) are inferred to the other species. High level events are also inferred for these events to allow for easier navigation.

[More details and caveats of the event inference in Reactome.](https://www.reactome.org) For details on PANTHER see also: <http://www.pantherdb.org/about.jsp>

SLC45A3 transports Glc from extracellular region to cytosol ↗

Location: [Cellular hexose transport](#)

Stable identifier: R-GGA-8875902

Type: transition

Compartments: plasma membrane, extracellular region, cytosol

Inferred from: [SLC45A3 transports Glc from extracellular region to cytosol \(Homo sapiens\)](#)

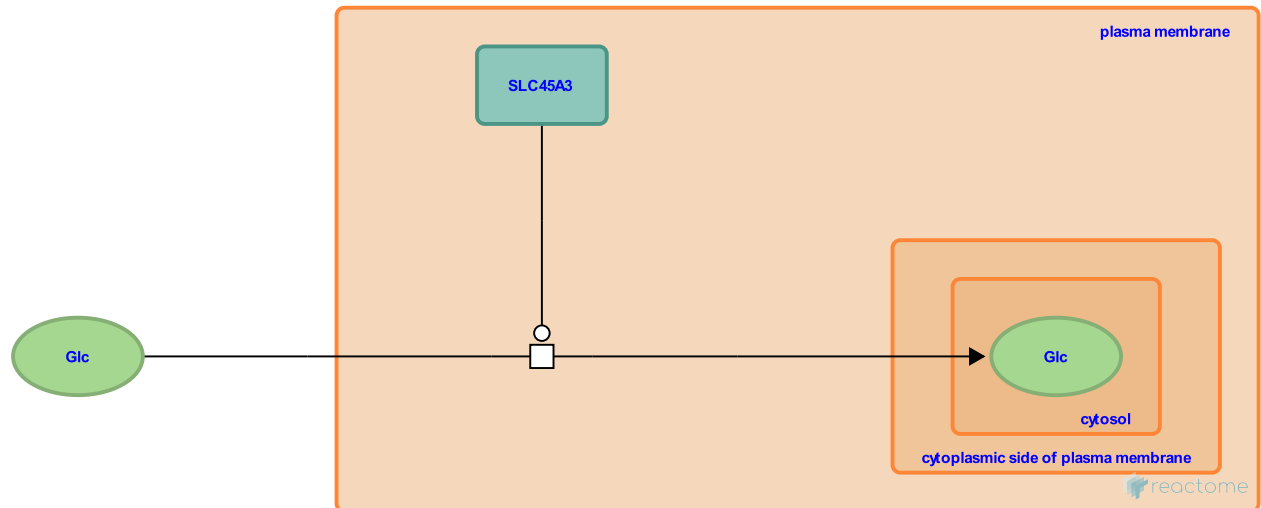

This event has been computationally inferred from an event that has been demonstrated in another species.

The inference is based on the homology mapping from PANTHER. Briefly, reactions for which all involved PhysicalEntities (in input, output and catalyst) have a mapped orthologue/paralogue (for complexes at least 75% of components must have a mapping) are inferred to the other species. High level events are also inferred for these events to allow for easier navigation.

[More details and caveats of the event inference in Reactome.](#) For details on PANTHER see also: <http://www.pantherdb.org/about.jsp>

Co-transport (influx) of glucose/mannose and Na⁺ ions by SGLT4 ↗

Location: Cellular hexose transport

Stable identifier: R-GGA-429567

Type: transition

Compartments: plasma membrane

Inferred from: Co-transport (influx) of glucose/mannose and Na⁺ ions by SGLT4 (Homo sapiens)

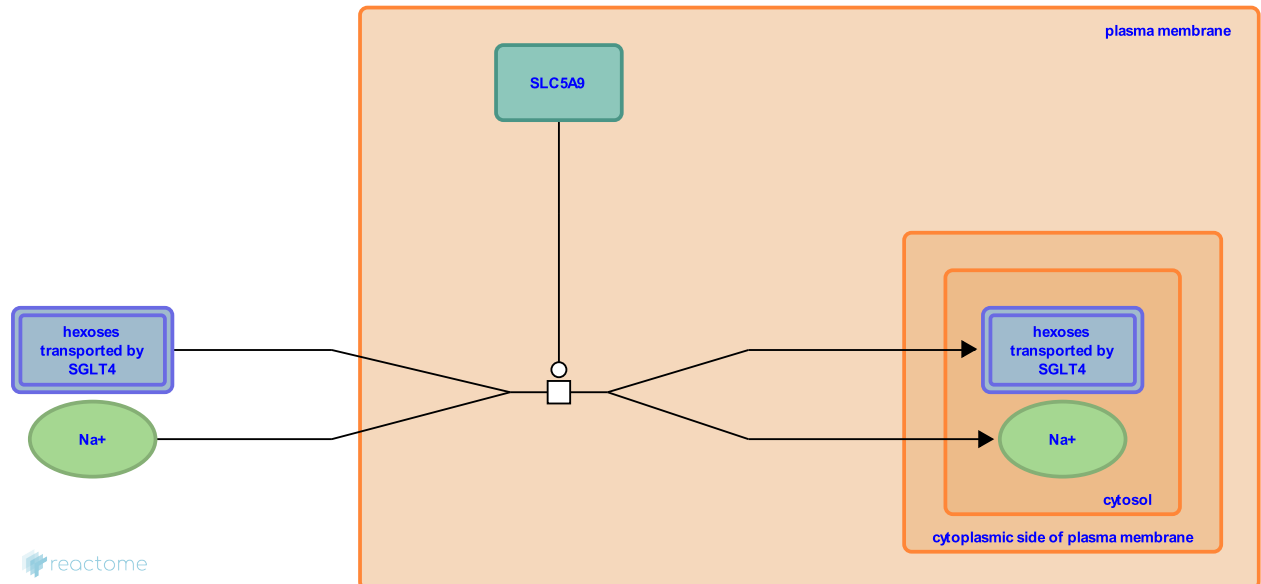

This event has been computationally inferred from an event that has been demonstrated in another species.

The inference is based on the homology mapping from PANTHER. Briefly, reactions for which all involved PhysicalEntities (in input, output and catalyst) have a mapped orthologue/paralogue (for complexes at least 75% of components must have a mapping) are inferred to the other species. High level events are also inferred for these events to allow for easier navigation.

[More details and caveats of the event inference in Reactome.](http://www.pantherdb.org/about.jsp) For details on PANTHER see also: <http://www.pantherdb.org/about.jsp>

Table of Contents

Introduction	1
⚡ Cellular hexose transport	2
↳ GLUT1 (SLC2A1) tetramer transports Glc from extracellular region to cytosol	3
↳ GLUT1 tetramer binds 4xATP	4
↳ GLUT1:ATP tetramer dissociates to GLUT1 tetramer and 4xATP	5
↳ GLUT2 (SLC2A2) tetramer transports Glc from extracellular region to cytosol	6
↳ GLUT2 (SLC2A2) transports Glc from cytosol to extracellular region	7
↳ GLUT3 (SLC2A3) tetramer transports Glc from extracellular region to cytosol	8
↳ GLUT4 (SLC2A4) tetramer transports Glc from extracellular region to cytosol	9
↳ SLC2A9 transports Fru, Glc, urate	10
↳ SLC2A6,8,10,12 transport Glc from extracellular region to cytosol	11
↳ GLUT7 and GLUT11 transport glucose and fructose	12
↳ GLUT14 (SLC2A14) tetramer transports Glc from extracellular region to cytosol	13
↳ SLC5A10 cotransports Na ⁺ with Man, Fru from extracellular region to cytosol	14
↳ SLC45A3 transports Glc from extracellular region to cytosol	15
↳ Co-transport (influx) of glucose/mannose and Na ⁺ ions by SGLT4	16
Table of Contents	17