

Innate Immune System

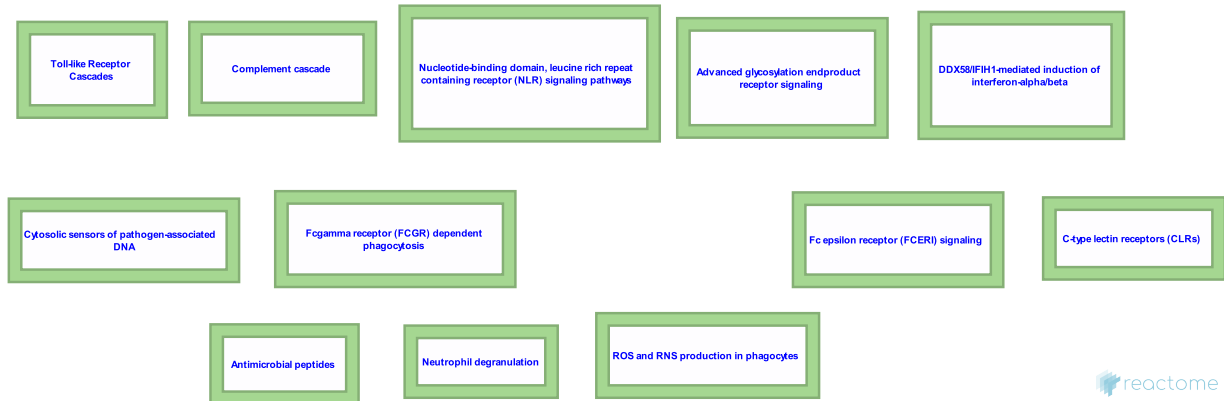

European Bioinformatics Institute, New York University Langone Medical Center, Ontario Institute for Cancer Research, Oregon Health and Science University.

The contents of this document may be freely copied and distributed in any media, provided the authors, plus the institutions, are credited, as stated under the terms of [Creative Commons Attribution 4.0 International \(CC BY 4.0\) License](https://creativecommons.org/licenses/by/4.0/). For more information see our [license](#).

This is just an excerpt of a full-length report for this pathway. To access the complete report, please download it at the [Reactome Textbook](#).

03/05/2024

Introduction

Reactome is open-source, open access, manually curated and peer-reviewed pathway database. Pathway annotations are authored by expert biologists, in collaboration with Reactome editorial staff and cross-referenced to many bioinformatics databases. A system of evidence tracking ensures that all assertions are backed up by the primary literature. Reactome is used by clinicians, geneticists, genomics researchers, and molecular biologists to interpret the results of high-throughput experimental studies, by bioinformaticians seeking to develop novel algorithms for mining knowledge from genomic studies, and by systems biologists building predictive models of normal and disease variant pathways.

The development of Reactome is supported by grants from the US National Institutes of Health (P41 HG003751), University of Toronto (CFREF Medicine by Design), European Union (EU STRP, EMI-CD), and the European Molecular Biology Laboratory (EBI Industry program).

Literature references

- Fabregat, A., Sidiropoulos, K., Viteri, G., Forner, O., Marin-Garcia, P., Arnau, V. et al. (2017). Reactome pathway analysis: a high-performance in-memory approach. *BMC bioinformatics*, 18, 142. [↗](#)
- Sidiropoulos, K., Viteri, G., Sevilla, C., Jupe, S., Webber, M., Orlic-Milacic, M. et al. (2017). Reactome enhanced pathway visualization. *Bioinformatics*, 33, 3461-3467. [↗](#)
- Fabregat, A., Jupe, S., Matthews, L., Sidiropoulos, K., Gillespie, M., Garapati, P. et al. (2018). The Reactome Pathway Knowledgebase. *Nucleic Acids Res*, 46, D649-D655. [↗](#)
- Fabregat, A., Korninger, F., Viteri, G., Sidiropoulos, K., Marin-Garcia, P., Ping, P. et al. (2018). Reactome graph database: Efficient access to complex pathway data. *PLoS computational biology*, 14, e1005968. [↗](#)

Reactome database release: 88

This document contains 13 pathways ([see Table of Contents](#))

Innate Immune System ↗

Stable identifier: R-DRE-168249

Inferred from: [Innate Immune System \(Homo sapiens\)](#)

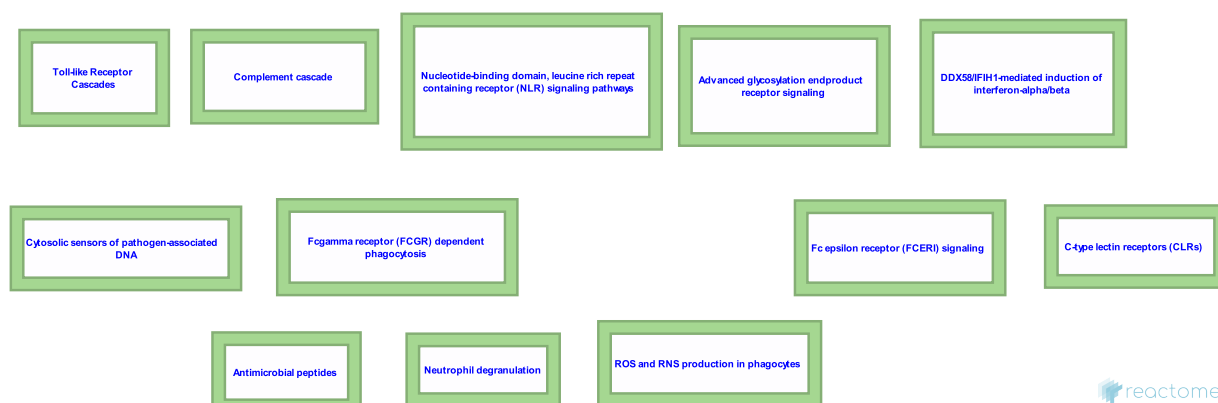

This event has been computationally inferred from an event that has been demonstrated in another species.

The inference is based on the homology mapping from PANTHER. Briefly, reactions for which all involved PhysicalEntities (in input, output and catalyst) have a mapped orthologue/paralogue (for complexes at least 75% of components must have a mapping) are inferred to the other species. High level events are also inferred for these events to allow for easier navigation.

[More details and caveats of the event inference in Reactome.](#) For details on PANTHER see also: <http://www.pantherdb.org/about.jsp>

Toll-like Receptor Cascades ↗

Location: Innate Immune System

Stable identifier: R-DRE-168898

Inferred from: Toll-like Receptor Cascades (Homo sapiens)

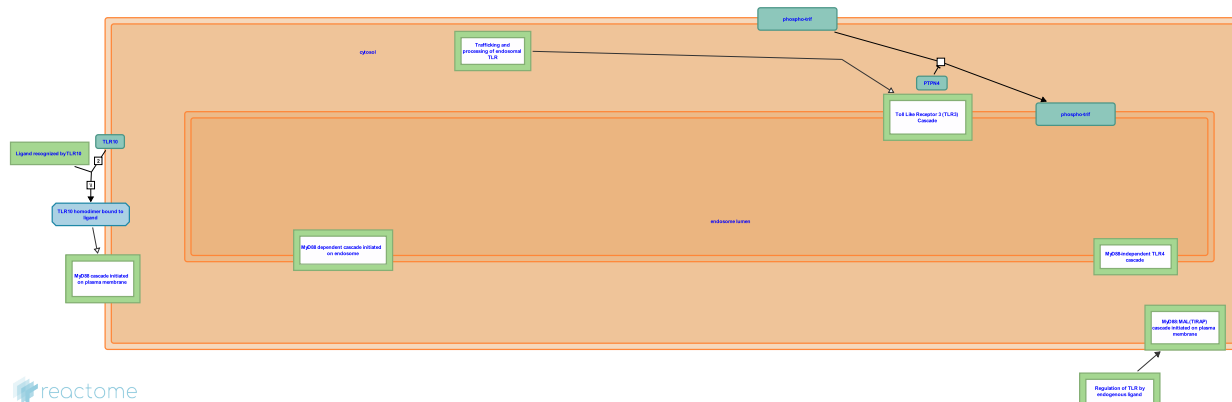

This event has been computationally inferred from an event that has been demonstrated in another species.

The inference is based on the homology mapping from PANTHER. Briefly, reactions for which all involved PhysicalEntities (in input, output and catalyst) have a mapped orthologue/paralogue (for complexes at least 75% of components must have a mapping) are inferred to the other species. High level events are also inferred for these events to allow for easier navigation.

[More details and caveats of the event inference in Reactome.](http://www.pantherdb.org/about.jsp) For details on PANTHER see also: <http://www.pantherdb.org/about.jsp>

Complement cascade ↗

Location: [Innate Immune System](#)

Stable identifier: R-DRE-166658

Compartments: plasma membrane, extracellular region

Inferred from: [Complement cascade \(Homo sapiens\)](#)

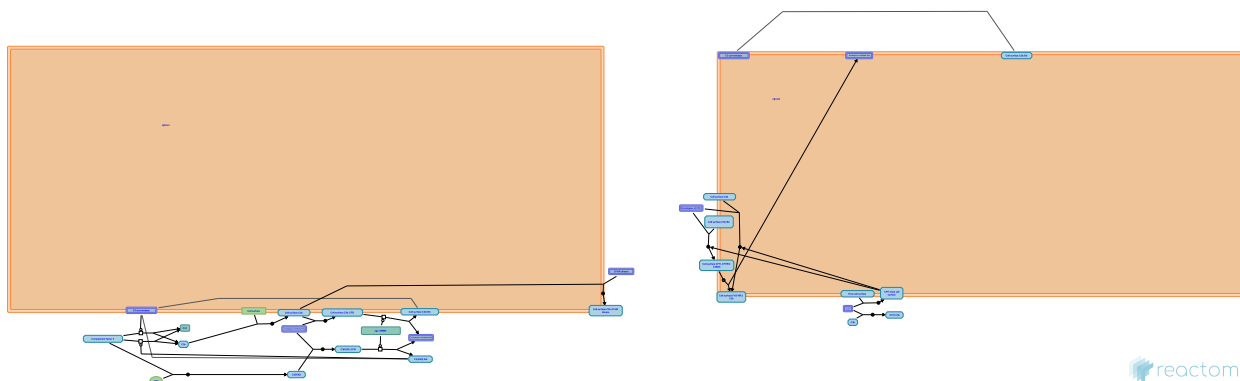

This event has been computationally inferred from an event that has been demonstrated in another species.

The inference is based on the homology mapping from PANTHER. Briefly, reactions for which all involved PhysicalEntities (in input, output and catalyst) have a mapped orthologue/paralogue (for complexes at least 75% of components must have a mapping) are inferred to the other species. High level events are also inferred for these events to allow for easier navigation.

[More details and caveats of the event inference in Reactome.](#) For details on PANTHER see also: <http://www.pantherdb.org/about.jsp>

Nucleotide-binding domain, leucine rich repeat containing receptor (NLR) signaling pathways ↗

Location: Innate Immune System

Stable identifier: R-DRE-168643

Compartments: cytosol

Inferred from: Nucleotide-binding domain, leucine rich repeat containing receptor (NLR) signaling pathways (Homo sapiens)

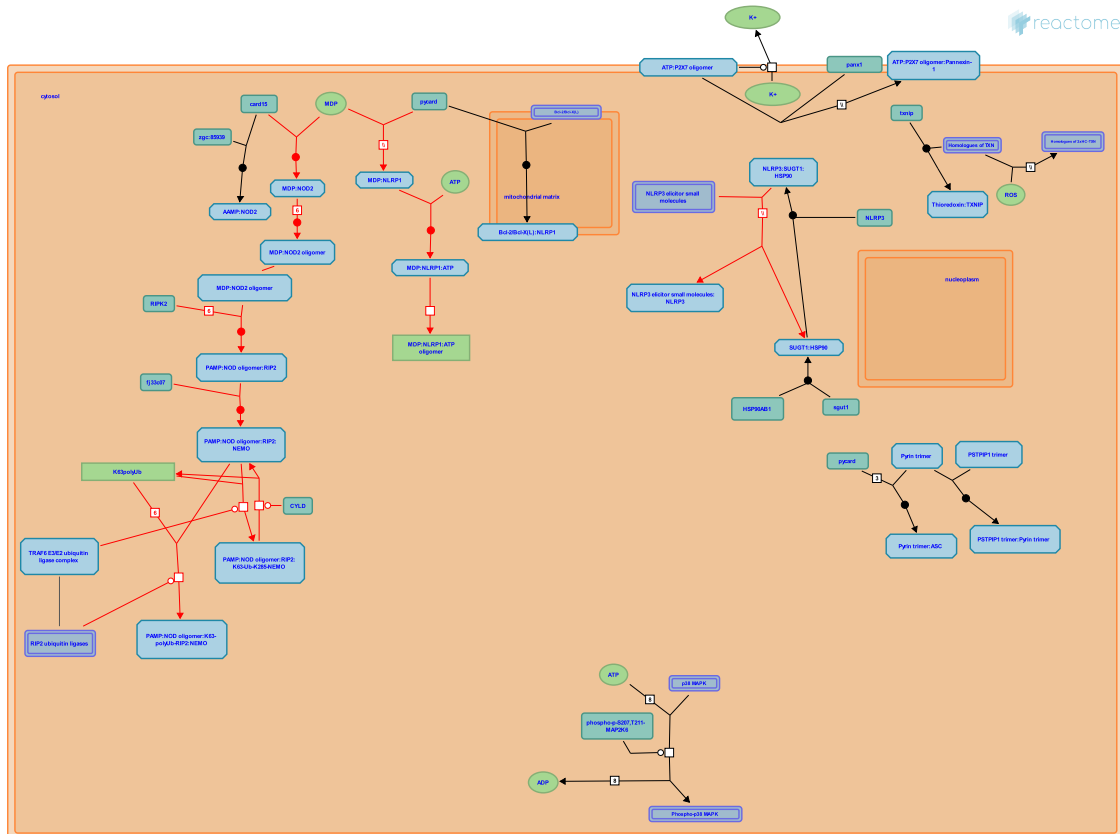

This event has been computationally inferred from an event that has been demonstrated in another species.

The inference is based on the homology mapping from PANTHER. Briefly, reactions for which all involved PhysicalEntities (in input, output and catalyst) have a mapped orthologue/paralogue (for complexes at least 75% of components must have a mapping) are inferred to the other species. High level events are also inferred for these events to allow for easier navigation.

[More details and caveats of the event inference in Reactome.](http://www.pantherdb.org/about.jsp) For details on PANTHER see also: <http://www.pantherdb.org/about.jsp>

Advanced glycosylation endproduct receptor signaling [↗](#)

Location: [Innate Immune System](#)

Stable identifier: R-DRE-879415

Compartments: plasma membrane, extracellular region

Inferred from: [Advanced glycosylation endproduct receptor signaling \(Homo sapiens\)](#)

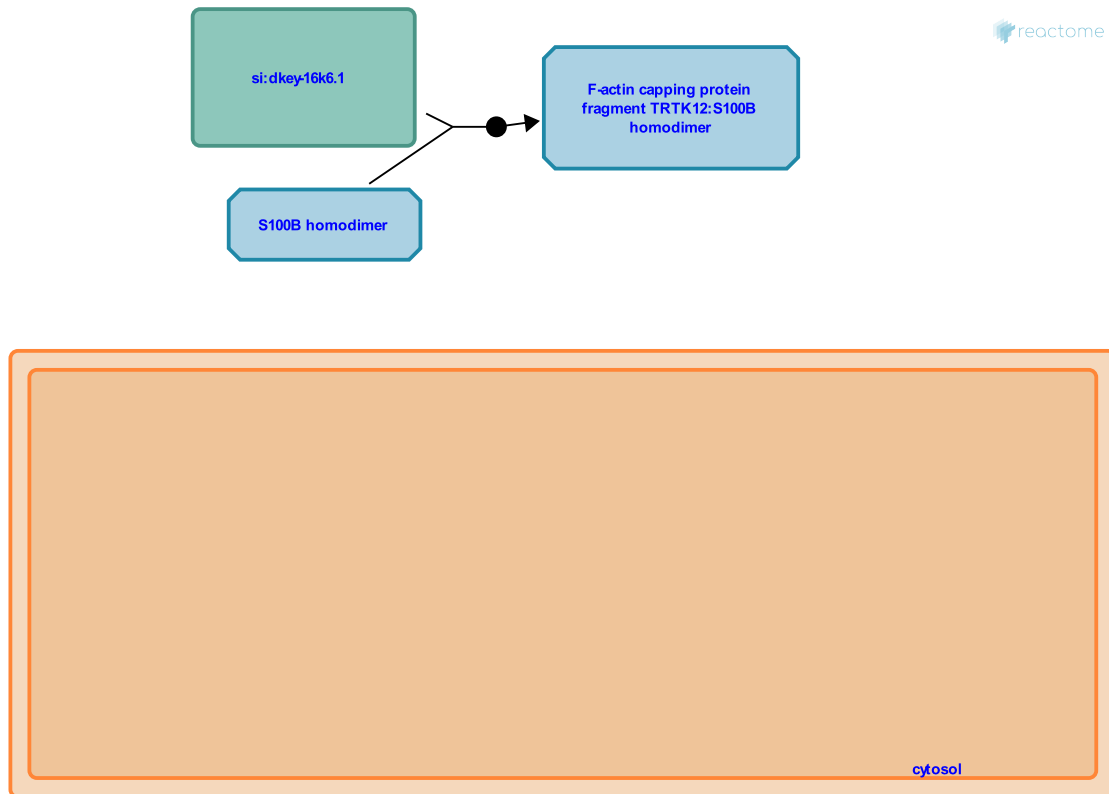

This event has been computationally inferred from an event that has been demonstrated in another species.

The inference is based on the homology mapping from PANTHER. Briefly, reactions for which all involved PhysicalEntities (in input, output and catalyst) have a mapped orthologue/paralogue (for complexes at least 75% of components must have a mapping) are inferred to the other species. High level events are also inferred for these events to allow for easier navigation.

[More details and caveats of the event inference in Reactome.](#) For details on PANTHER see also: <http://www.pantherdb.org/about.jsp>

DDX58/IFIH1-mediated induction of interferon-alpha/beta ↗

Location: Innate Immune System

Stable identifier: R-DRE-168928

Compartments: mitochondrial outer membrane

Inferred from: [DDX58/IFIH1-mediated induction of interferon-alpha/beta \(Homo sapiens\)](#)

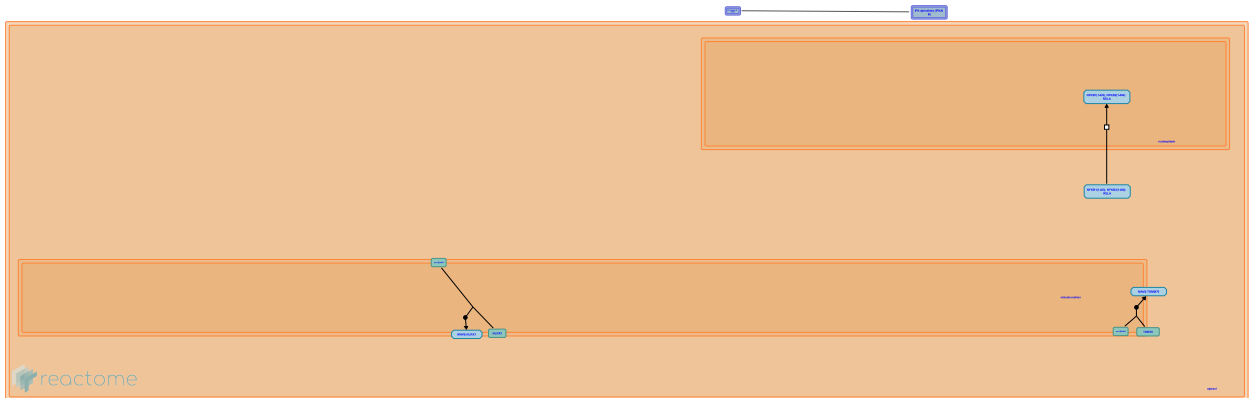

This event has been computationally inferred from an event that has been demonstrated in another species.

The inference is based on the homology mapping from PANTHER. Briefly, reactions for which all involved PhysicalEntities (in input, output and catalyst) have a mapped orthologue/paralogue (for complexes at least 75% of components must have a mapping) are inferred to the other species. High level events are also inferred for these events to allow for easier navigation.

[More details and caveats of the event inference in Reactome.](#) For details on PANTHER see also: <http://www.pantherdb.org/about.jsp>

Cytosolic sensors of pathogen-associated DNA ↗

Location: Innate Immune System

Stable identifier: R-DRE-1834949

Inferred from: Cytosolic sensors of pathogen-associated DNA (Homo sapiens)

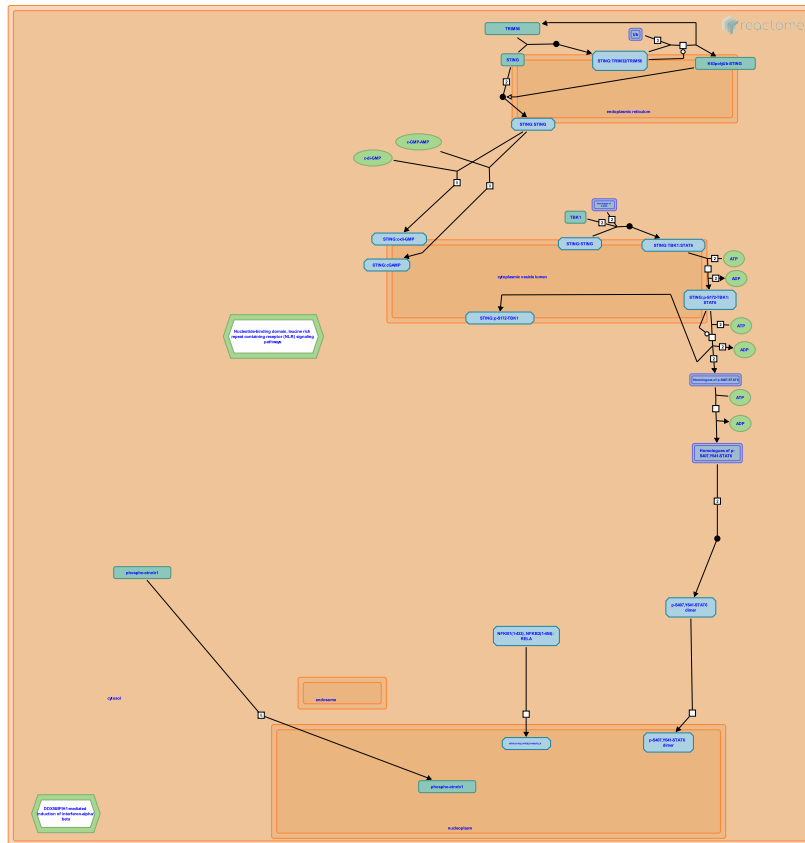

This event has been computationally inferred from an event that has been demonstrated in another species.

The inference is based on the homology mapping from PANTHER. Briefly, reactions for which all involved PhysicalEntities (in input, output and catalyst) have a mapped orthologue/paralogue (for complexes at least 75% of components must have a mapping) are inferred to the other species. High level events are also inferred for these events to allow for easier navigation.

[More details and caveats of the event inference in Reactome.](http://www.pantherdb.org/about.jsp) For details on PANTHER see also: <http://www.pantherdb.org/about.jsp>

Fc gamma receptor (FCGR) dependent phagocytosis ↗

Location: [Innate Immune System](#)

Stable identifier: R-DRE-2029480

Inferred from: [Fc gamma receptor \(FCGR\) dependent phagocytosis \(Homo sapiens\)](#)

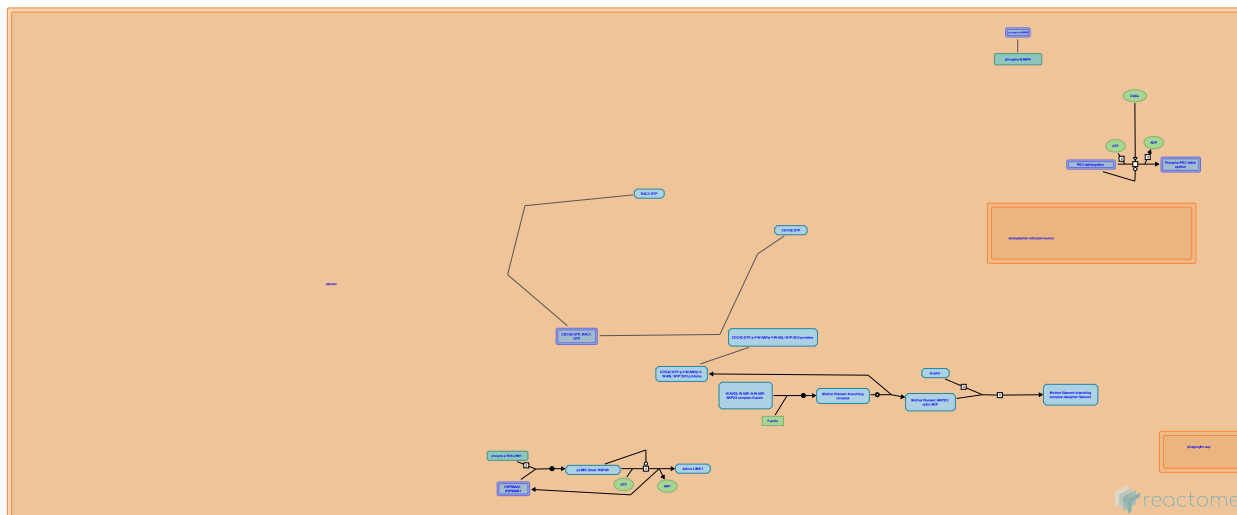

This event has been computationally inferred from an event that has been demonstrated in another species.

The inference is based on the homology mapping from PANTHER. Briefly, reactions for which all involved PhysicalEntities (in input, output and catalyst) have a mapped orthologue/paralogue (for complexes at least 75% of components must have a mapping) are inferred to the other species. High level events are also inferred for these events to allow for easier navigation.

[More details and caveats of the event inference in Reactome.](#) For details on PANTHER see also: <http://www.pantherdb.org/about.jsp>

Fc epsilon receptor (FCERI) signaling ↗

Location: [Innate Immune System](#)

Stable identifier: R-DRE-2454202

Compartments: plasma membrane

Inferred from: [Fc epsilon receptor \(FCERI\) signaling \(Homo sapiens\)](#)

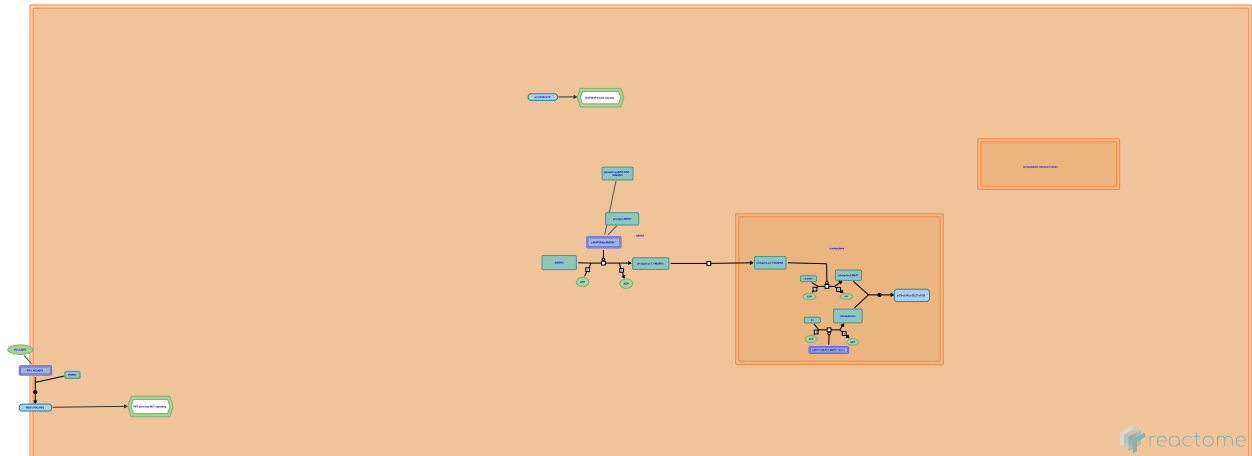

This event has been computationally inferred from an event that has been demonstrated in another species.

The inference is based on the homology mapping from PANTHER. Briefly, reactions for which all involved PhysicalEntities (in input, output and catalyst) have a mapped orthologue/paralogue (for complexes at least 75% of components must have a mapping) are inferred to the other species. High level events are also inferred for these events to allow for easier navigation.

[More details and caveats of the event inference in Reactome.](#) For details on PANTHER see also: <http://www.pantherdb.org/about.jsp>

C-type lectin receptors (CLRs) ↗

Location: [Innate Immune System](#)

Stable identifier: R-DRE-5621481

Compartments: plasma membrane, nucleoplasm, cytosol

Inferred from: [C-type lectin receptors \(CLRs\) \(Homo sapiens\)](#)

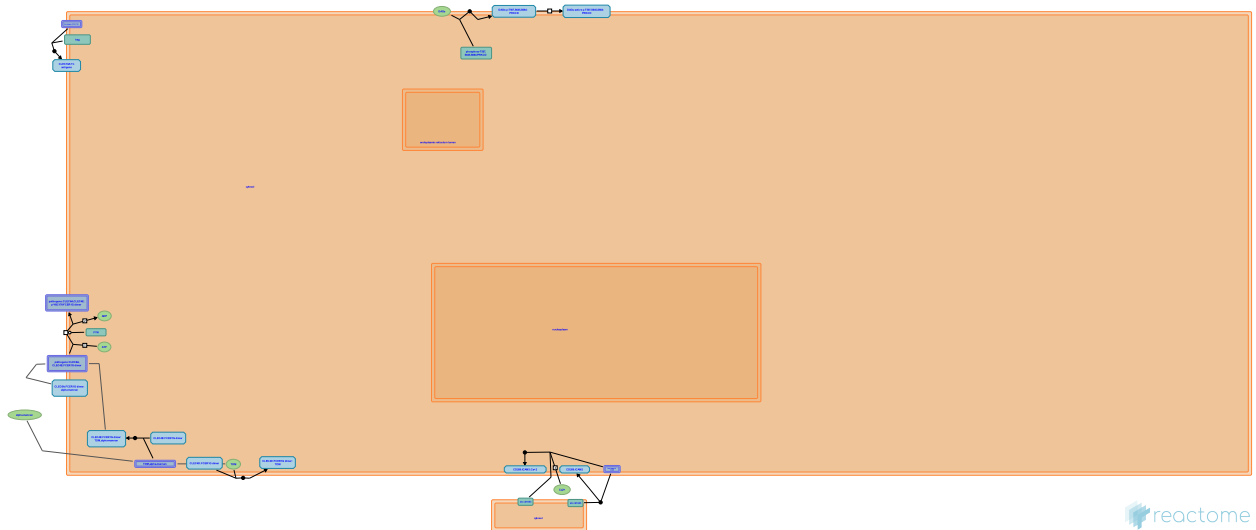

This event has been computationally inferred from an event that has been demonstrated in another species.

The inference is based on the homology mapping from PANTHER. Briefly, reactions for which all involved PhysicalEntities (in input, output and catalyst) have a mapped orthologue/paralogue (for complexes at least 75% of components must have a mapping) are inferred to the other species. High level events are also inferred for these events to allow for easier navigation.

[More details and caveats of the event inference in Reactome.](#) For details on PANTHER see also: <http://www.pantherdb.org/about.jsp>

Antimicrobial peptides ↗

Location: Innate Immune System

Stable identifier: R-DRE-6803157

Inferred from: Antimicrobial peptides (Homo sapiens)

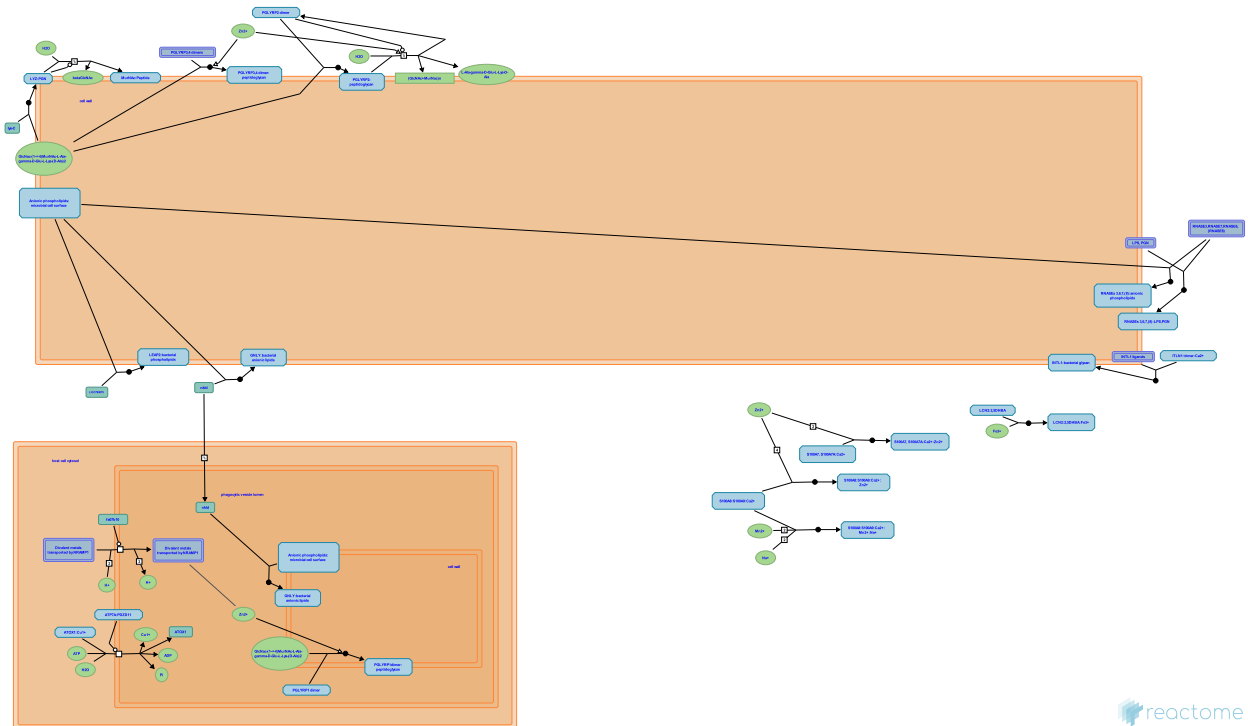

This event has been computationally inferred from an event that has been demonstrated in another species.

The inference is based on the homology mapping from PANTHER. Briefly, reactions for which all involved PhysicalEntities (in input, output and catalyst) have a mapped orthologue/paralogue (for complexes at least 75% of components must have a mapping) are inferred to the other species. High level events are also inferred for these events to allow for easier navigation.

[More details and caveats of the event inference in Reactome.](http://www.reactome.org) For details on PANTHER see also: <http://www.pantherdb.org/about.jsp>

Neutrophil degranulation ↗

Location: Innate Immune System

Stable identifier: R-DRE-6798695

Inferred from: Neutrophil degranulation (Homo sapiens)

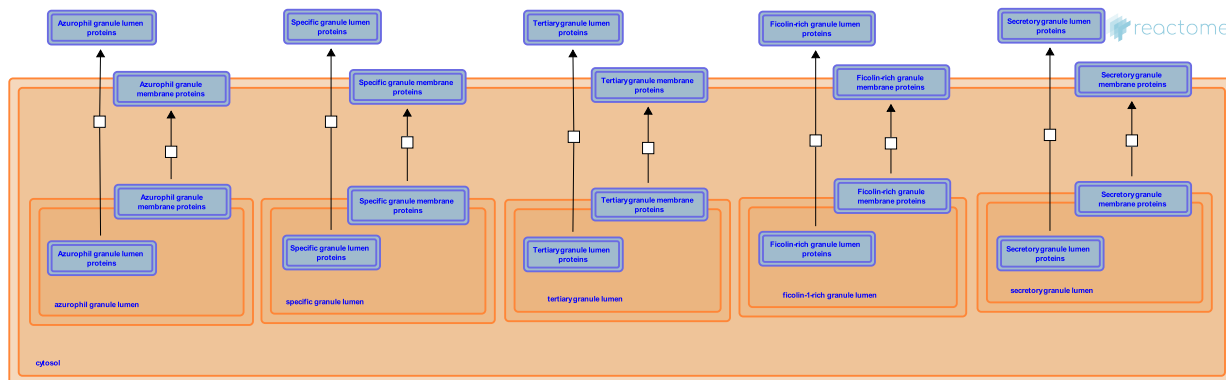

This event has been computationally inferred from an event that has been demonstrated in another species.

The inference is based on the homology mapping from PANTHER. Briefly, reactions for which all involved PhysicalEntities (in input, output and catalyst) have a mapped orthologue/paralogue (for complexes at least 75% of components must have a mapping) are inferred to the other species. High level events are also inferred for these events to allow for easier navigation.

[More details and caveats of the event inference in Reactome.](http://www.pantherdb.org/about.jsp) For details on PANTHER see also: <http://www.pantherdb.org/about.jsp>

ROS and RNS production in phagocytes ↗

Location: Innate Immune System

Stable identifier: R-DRE-1222556

Inferred from: ROS and RNS production in phagocytes (Homo sapiens)

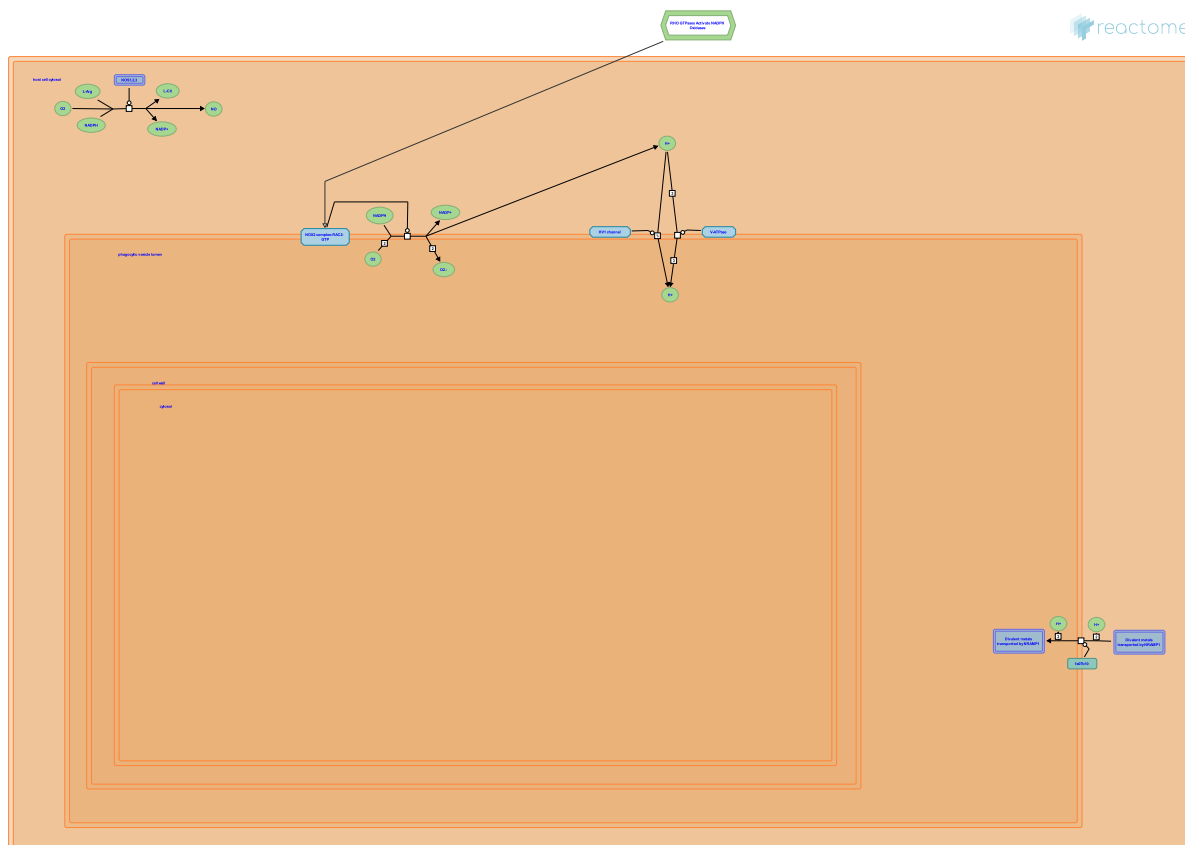

This event has been computationally inferred from an event that has been demonstrated in another species.

The inference is based on the homology mapping from PANTHER. Briefly, reactions for which all involved PhysicalEntities (in input, output and catalyst) have a mapped orthologue/paralogue (for complexes at least 75% of components must have a mapping) are inferred to the other species. High level events are also inferred for these events to allow for easier navigation.

[More details and caveats of the event inference in Reactome.](http://www.pantherdb.org/about.jsp) For details on PANTHER see also: <http://www.pantherdb.org/about.jsp>

Table of Contents

Introduction	1
❖ Innate Immune System	2
❖ Toll-like Receptor Cascades	3
❖ Complement cascade	4
❖ Nucleotide-binding domain, leucine rich repeat containing receptor (NLR) signaling pathways	5
❖ Advanced glycosylation endproduct receptor signaling	6
❖ DDX58/IFIH1-mediated induction of interferon-alpha/beta	7
❖ Cytosolic sensors of pathogen-associated DNA	8
❖ Fc gamma receptor (FCGR) dependent phagocytosis	9
❖ Fc epsilon receptor (FCERI) signaling	10
❖ C-type lectin receptors (CLRs)	11
❖ Antimicrobial peptides	12
❖ Neutrophil degranulation	13
❖ ROS and RNS production in phagocytes	14
Table of Contents	15