

RAF/MAP kinase cascade

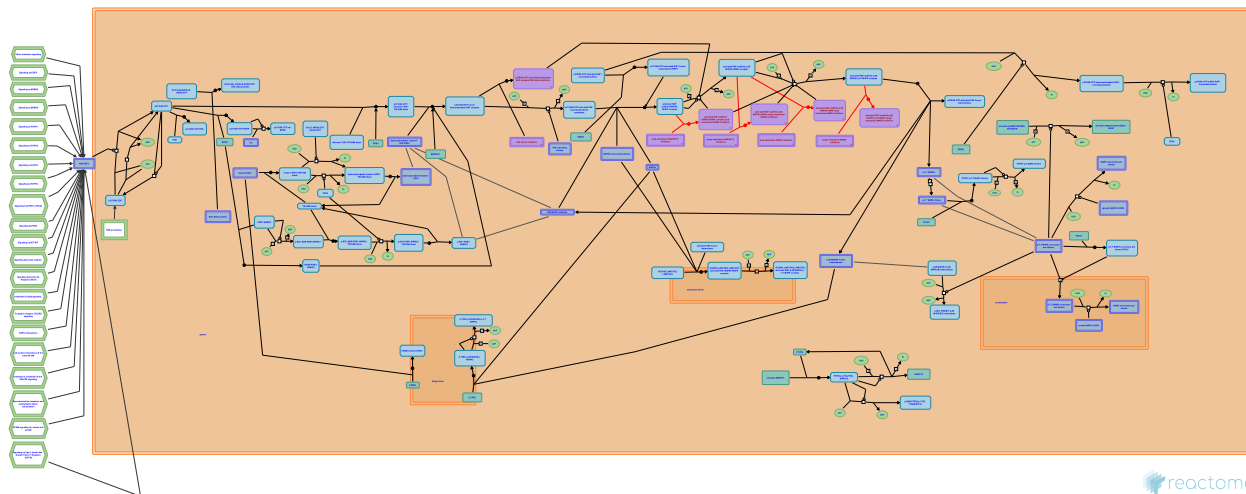

European Bioinformatics Institute, New York University Langone Medical Center, Ontario Institute for Cancer Research, Oregon Health and Science University.

The contents of this document may be freely copied and distributed in any media, provided the authors, plus the institutions, are credited, as stated under the terms of [Creative Commons Attribution 4.0 International \(CC BY 4.0\) License](https://creativecommons.org/licenses/by/4.0/). For more information see our [license](https://reactome.org/licenses/).

This is just an excerpt of a full-length report for this pathway. To access the complete report, please download it at the [Reactome Textbook](https://reactome.org/textbook/).

02/05/2024

Introduction

Reactome is open-source, open access, manually curated and peer-reviewed pathway database. Pathway annotations are authored by expert biologists, in collaboration with Reactome editorial staff and cross-referenced to many bioinformatics databases. A system of evidence tracking ensures that all assertions are backed up by the primary literature. Reactome is used by clinicians, geneticists, genomics researchers, and molecular biologists to interpret the results of high-throughput experimental studies, by bioinformaticians seeking to develop novel algorithms for mining knowledge from genomic studies, and by systems biologists building predictive models of normal and disease variant pathways.

The development of Reactome is supported by grants from the US National Institutes of Health (P41 HG003751), University of Toronto (CFREF Medicine by Design), European Union (EU STRP, EMI-CD), and the European Molecular Biology Laboratory (EBI Industry program).

Literature references

- Fabregat, A., Sidiropoulos, K., Viteri, G., Forner, O., Marin-Garcia, P., Arnau, V. et al. (2017). Reactome pathway analysis: a high-performance in-memory approach. *BMC bioinformatics*, 18, 142. [↗](#)
- Sidiropoulos, K., Viteri, G., Sevilla, C., Jupe, S., Webber, M., Orlic-Milacic, M. et al. (2017). Reactome enhanced pathway visualization. *Bioinformatics*, 33, 3461-3467. [↗](#)
- Fabregat, A., Jupe, S., Matthews, L., Sidiropoulos, K., Gillespie, M., Garapati, P. et al. (2018). The Reactome Pathway Knowledgebase. *Nucleic Acids Res*, 46, D649-D655. [↗](#)
- Fabregat, A., Korninger, F., Viteri, G., Sidiropoulos, K., Marin-Garcia, P., Ping, P. et al. (2018). Reactome graph database: Efficient access to complex pathway data. *PLoS computational biology*, 14, e1005968. [↗](#)

Reactome database release: 88

This document contains 5 pathways and 8 reactions ([see Table of Contents](#))

RAF/MAP kinase cascade ↗

Stable identifier: R-BTA-5673001

Inferred from: [RAF/MAP kinase cascade \(Homo sapiens\)](#)

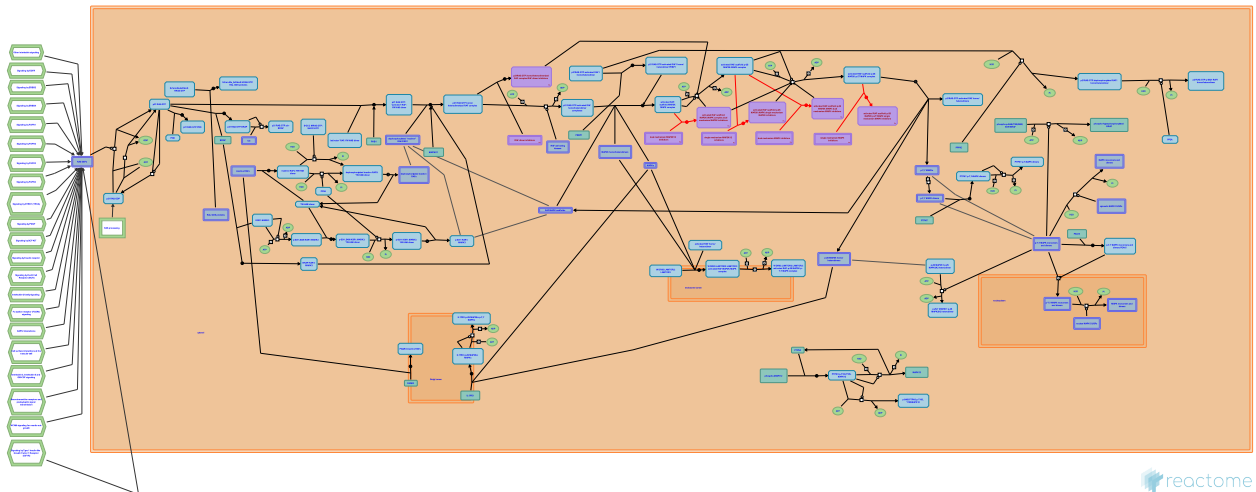

This event has been computationally inferred from an event that has been demonstrated in another species.

The inference is based on the homology mapping from PANTHER. Briefly, reactions for which all involved PhysicalEntities (in input, output and catalyst) have a mapped orthologue/paralogue (for complexes at least 75% of components must have a mapping) are inferred to the other species. High level events are also inferred for these events to allow for easier navigation.

[More details and caveats of the event inference in Reactome.](#) For details on PANTHER see also: <http://www.pantherdb.org/about.jsp>

RAS processing ↗

Location: RAF/MAP kinase cascade

Stable identifier: R-BTA-9648002

Inferred from: RAS processing (Homo sapiens)

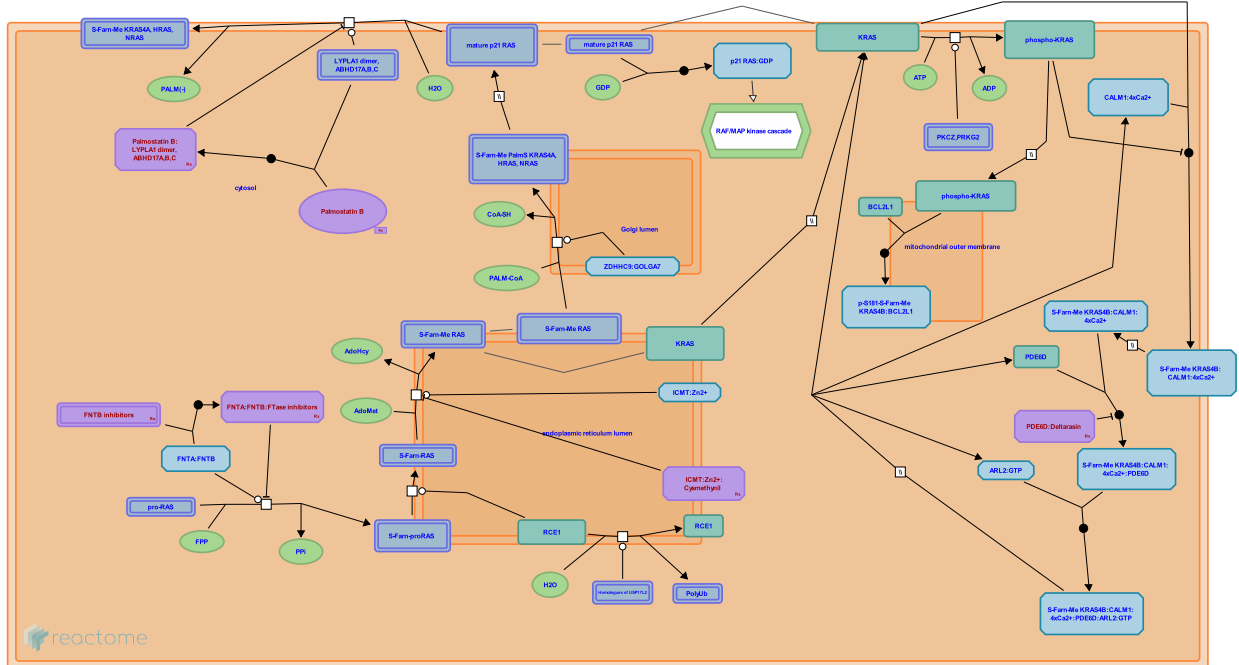

This event has been computationally inferred from an event that has been demonstrated in another species.

The inference is based on the homology mapping from PANTHER. Briefly, reactions for which all involved PhysicalEntities (in input, output and catalyst) have a mapped orthologue/paralogue (for complexes at least 75% of components must have a mapping) are inferred to the other species. High level events are also inferred for these events to allow for easier navigation.

[More details and caveats of the event inference in Reactome.](http://www.pantherdb.org/about.jsp) For details on PANTHER see also: <http://www.pantherdb.org/about.jsp>

RAS intrinsic GTPase activity hydrolyzes GTP to GDP ↗

Location: [RAF/MAP kinase cascade](#)

Stable identifier: R-BTA-9649736

Type: transition

Compartments: plasma membrane

Inferred from: [RAS intrinsic GTPase activity hydrolyzes GTP to GDP \(Homo sapiens\)](#)

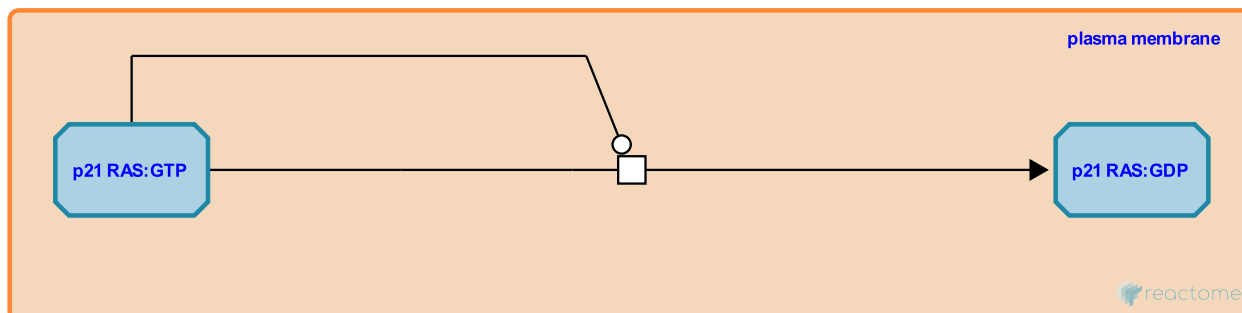

This event has been computationally inferred from an event that has been demonstrated in another species.

The inference is based on the homology mapping from PANTHER. Briefly, reactions for which all involved PhysicalEntities (in input, output and catalyst) have a mapped orthologue/paralogue (for complexes at least 75% of components must have a mapping) are inferred to the other species. High level events are also inferred for these events to allow for easier navigation.

[More details and caveats of the event inference in Reactome.](#) For details on PANTHER see also: <http://www.pantherdb.org/about.jsp>

Preceded by: [Intrinsic nucleotide exchange on RAS](#)

Followed by: [Intrinsic nucleotide exchange on RAS](#)

Intrinsic nucleotide exchange on RAS ↗

Location: [RAF/MAP kinase cascade](#)

Stable identifier: R-BTA-9649735

Type: transition

Compartments: plasma membrane, cytosol

Inferred from: [Intrinsic nucleotide exchange on RAS \(Homo sapiens\)](#)

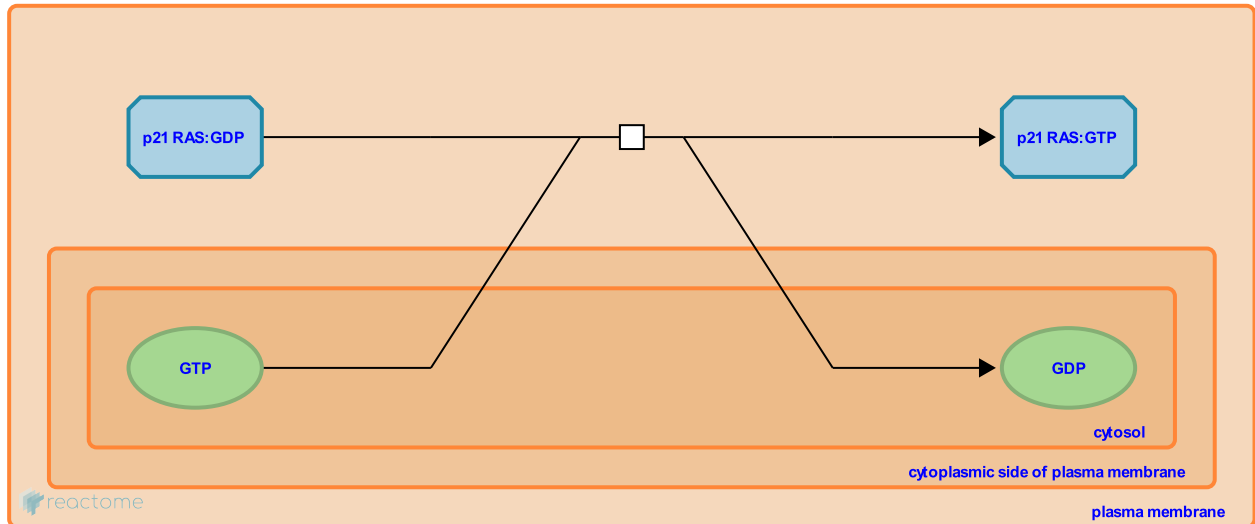

This event has been computationally inferred from an event that has been demonstrated in another species.

The inference is based on the homology mapping from PANTHER. Briefly, reactions for which all involved PhysicalEntities (in input, output and catalyst) have a mapped orthologue/paralogue (for complexes at least 75% of components must have a mapping) are inferred to the other species. High level events are also inferred for these events to allow for easier navigation.

[More details and caveats of the event inference in Reactome.](#) For details on PANTHER see also: <http://www.pantherdb.org/about.jsp>

Preceded by: [RAS intrinsic GTPase activity hydrolyzes GTP to GDP](#)

Followed by: [RAS intrinsic GTPase activity hydrolyzes GTP to GDP](#)

RAS GEFs promote RAS nucleotide exchange ↗

Location: [RAF/MAP kinase cascade](#)

Stable identifier: R-BTA-5672965

Type: transition

Compartments: plasma membrane

Inferred from: [RAS GEFs promote RAS nucleotide exchange \(Homo sapiens\)](#)

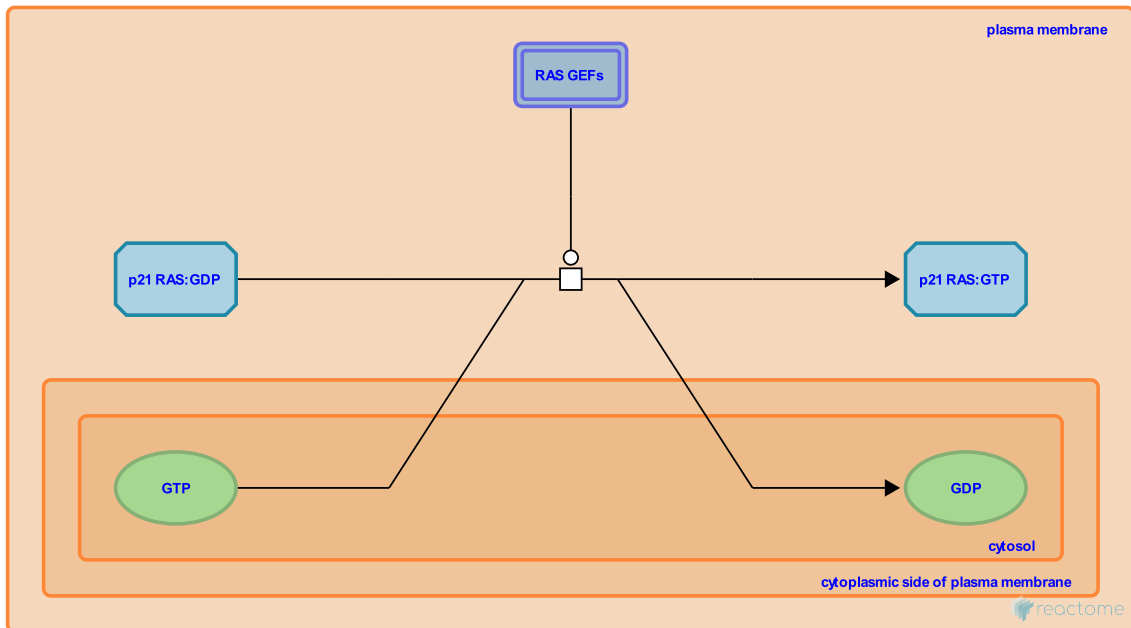

This event has been computationally inferred from an event that has been demonstrated in another species.

The inference is based on the homology mapping from PANTHER. Briefly, reactions for which all involved PhysicalEntities (in input, output and catalyst) have a mapped orthologue/paralogue (for complexes at least 75% of components must have a mapping) are inferred to the other species. High level events are also inferred for these events to allow for easier navigation.

[More details and caveats of the event inference in Reactome.](#) For details on PANTHER see also: <http://www.pantherdb.org/about.jsp>

Followed by: [RAS:GTP binds RAL GDS proteins](#), [RAS:GTP binds PI3K](#)

RAS:GTP binds PI3K ↗

Location: [RAF/MAP kinase cascade](#)

Stable identifier: R-BTA-9658253

Type: binding

Compartments: plasma membrane, cytosol

Inferred from: [RAS:GTP binds PI3K \(Homo sapiens\)](#)

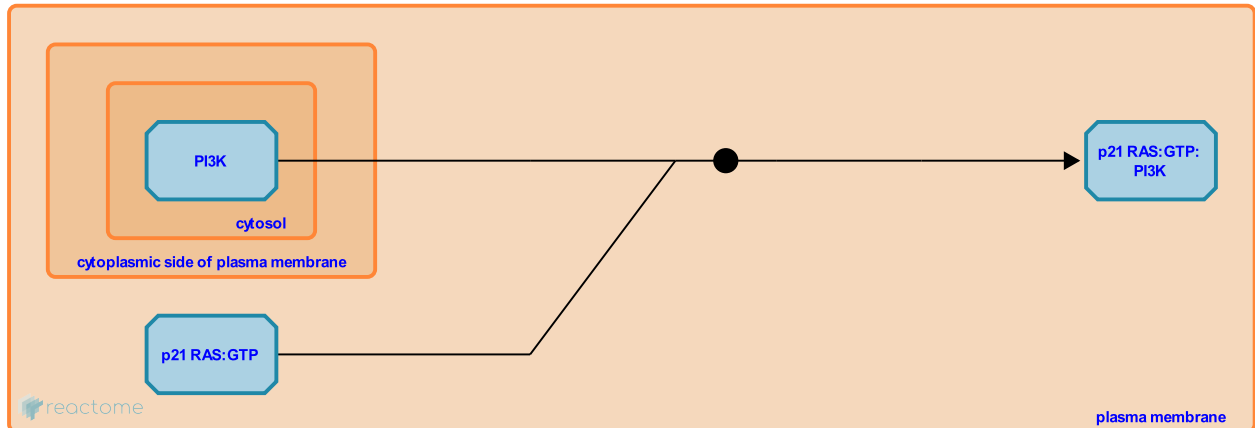

This event has been computationally inferred from an event that has been demonstrated in another species.

The inference is based on the homology mapping from PANTHER. Briefly, reactions for which all involved PhysicalEntities (in input, output and catalyst) have a mapped orthologue/paralogue (for complexes at least 75% of components must have a mapping) are inferred to the other species. High level events are also inferred for these events to allow for easier navigation.

[More details and caveats of the event inference in Reactome.](#) For details on PANTHER see also: <http://www.pantherdb.org/about.jsp>

Preceded by: [RAS GEFs promote RAS nucleotide exchange](#)

RAS:GTP binds RAL GDS proteins ↗

Location: [RAF/MAP kinase cascade](#)

Stable identifier: R-BTA-9660557

Type: binding

Compartments: plasma membrane, cytosol

Inferred from: [RAS:GTP binds RAL GDS proteins \(Homo sapiens\)](#)

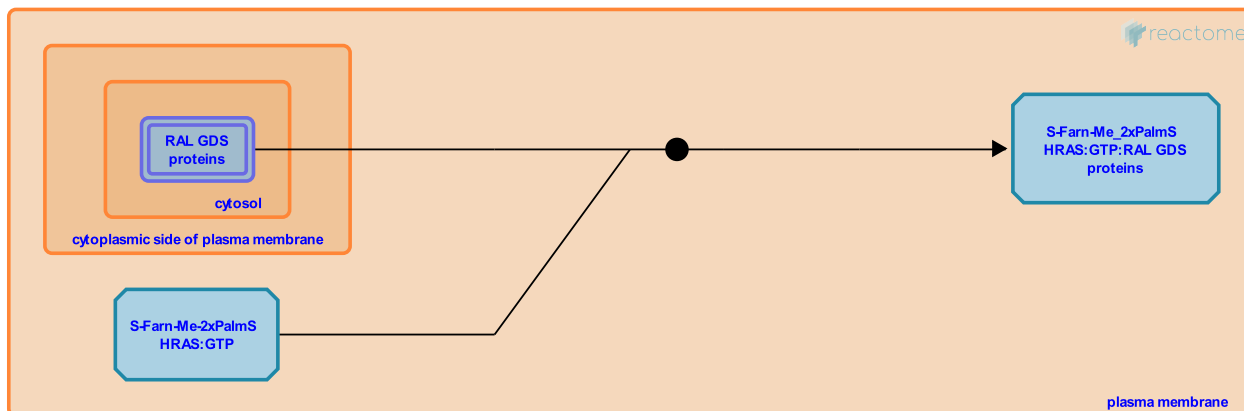

This event has been computationally inferred from an event that has been demonstrated in another species.

The inference is based on the homology mapping from PANTHER. Briefly, reactions for which all involved PhysicalEntities (in input, output and catalyst) have a mapped orthologue/paralogue (for complexes at least 75% of components must have a mapping) are inferred to the other species. High level events are also inferred for these events to allow for easier navigation.

[More details and caveats of the event inference in Reactome.](#) For details on PANTHER see also: <http://www.pantherdb.org/about.jsp>

Preceded by: [RAS GEFs promote RAS nucleotide exchange](#)

RAF activation ↗

Location: RAF/MAP kinase cascade

Stable identifier: R-BTA-5673000

Inferred from: RAF activation (Homo sapiens)

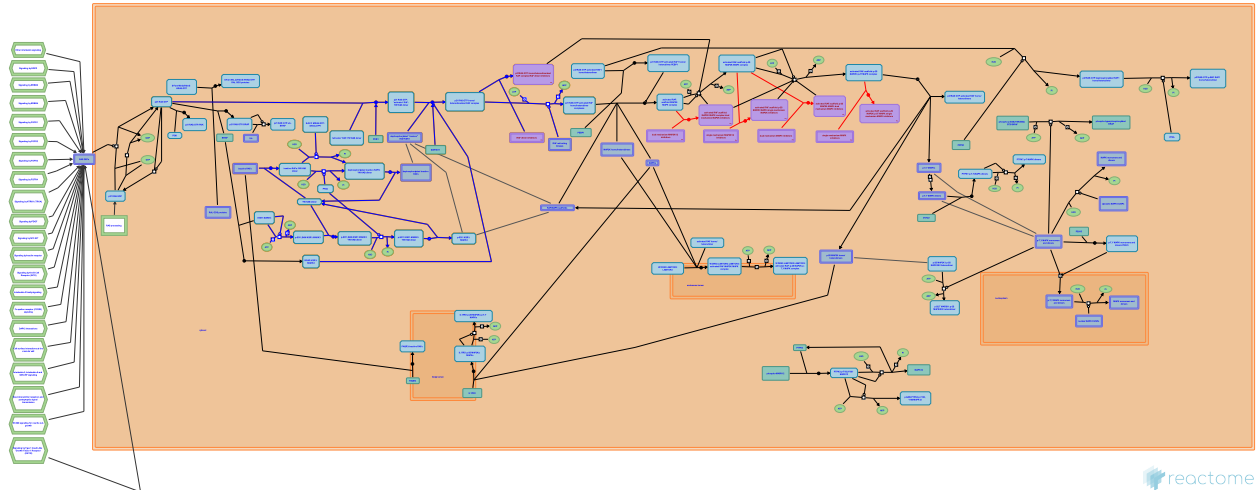

This event has been computationally inferred from an event that has been demonstrated in another species.

The inference is based on the homology mapping from PANTHER. Briefly, reactions for which all involved PhysicalEntities (in input, output and catalyst) have a mapped orthologue/paralogue (for complexes at least 75% of components must have a mapping) are inferred to the other species. High level events are also inferred for these events to allow for easier navigation.

[More details and caveats of the event inference in Reactome.](https://www.reactome.org) For details on PANTHER see also: <http://www.pantherdb.org/about.jsp>

MAP2K and MAPK activation ↗

Location: RAF/MAP kinase cascade

Stable identifier: R-BTA-5674135

Inferred from: MAP2K and MAPK activation (Homo sapiens)

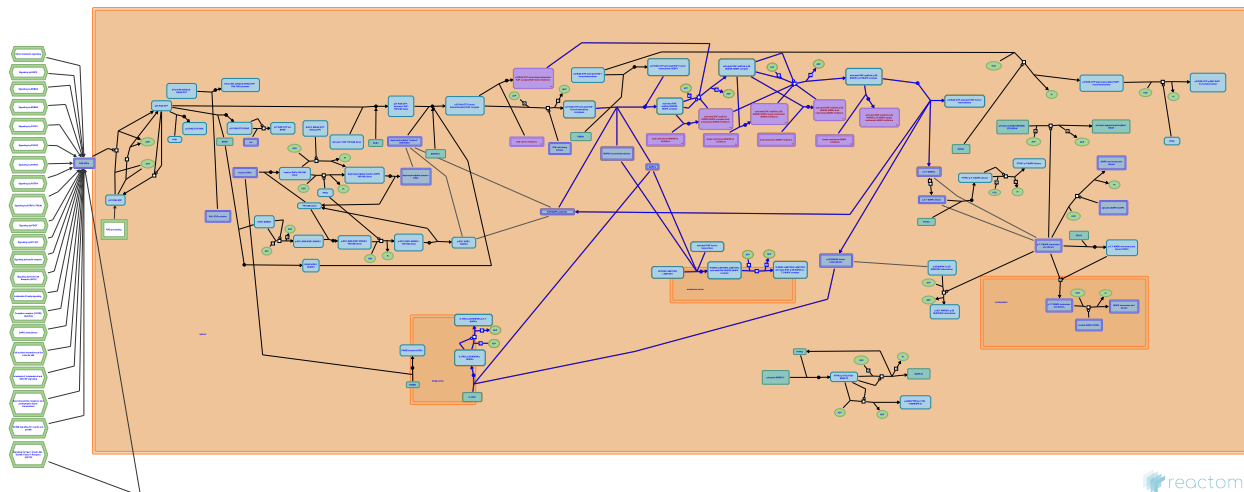

This event has been computationally inferred from an event that has been demonstrated in another species.

The inference is based on the homology mapping from PANTHER. Briefly, reactions for which all involved PhysicalEntities (in input, output and catalyst) have a mapped orthologue/paralogue (for complexes at least 75% of components must have a mapping) are inferred to the other species. High level events are also inferred for these events to allow for easier navigation.

[More details and caveats of the event inference in Reactome.](https://www.reactome.org) For details on PANTHER see also: <http://www.pantherdb.org/about.jsp>

p-T,Y MAPKs dimerize ↗

Location: [RAF/MAP kinase cascade](#)

Stable identifier: R-BTA-5674385

Type: transition

Compartments: cytosol

Inferred from: [p-T,Y MAPKs dimerize \(Homo sapiens\)](#)

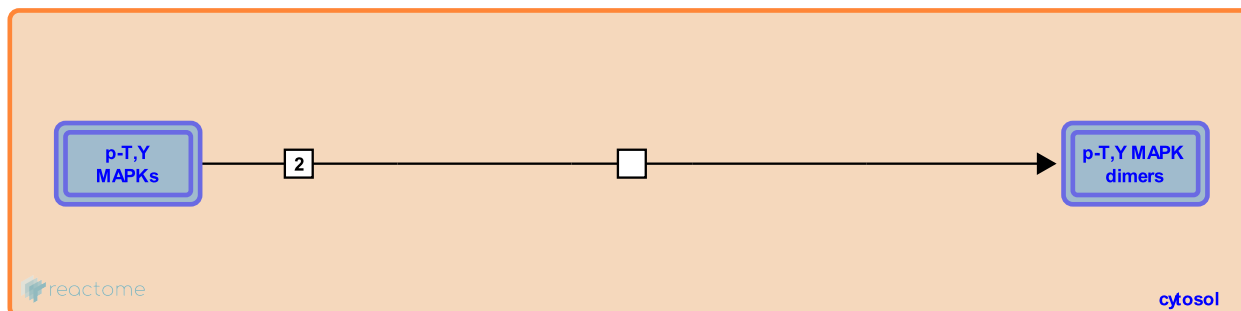

This event has been computationally inferred from an event that has been demonstrated in another species.

The inference is based on the homology mapping from PANTHER. Briefly, reactions for which all involved PhysicalEntities (in input, output and catalyst) have a mapped orthologue/paralogue (for complexes at least 75% of components must have a mapping) are inferred to the other species. High level events are also inferred for these events to allow for easier navigation.

[More details and caveats of the event inference in Reactome.](#) For details on PANTHER see also: <http://www.pantherdb.org/about.jsp>

Followed by: [PEA15 binds MAPK monomers and dimers](#), [Phosphorylated MAPKs translocate into the nucleus](#)

Phosphorylated MAPKs translocate into the nucleus ↗

Location: [RAF/MAP kinase cascade](#)

Stable identifier: R-BTA-5674387

Type: omitted

Compartments: nucleoplasm

Inferred from: [Phosphorylated MAPKs translocate into the nucleus \(Homo sapiens\)](#)

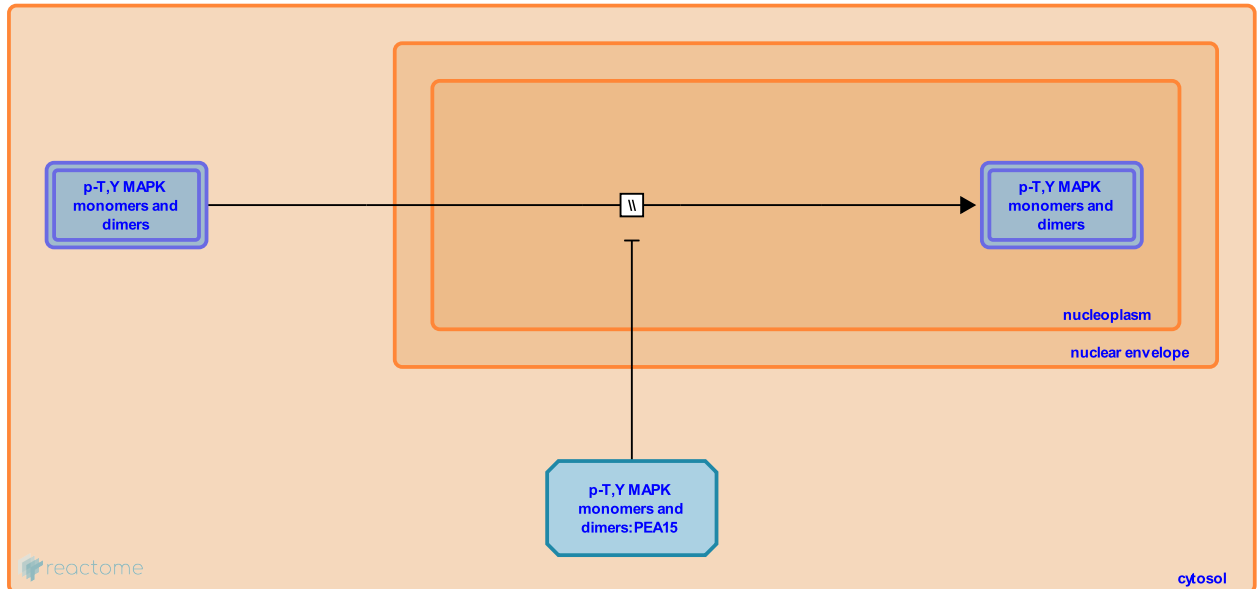

This event has been computationally inferred from an event that has been demonstrated in another species.

The inference is based on the homology mapping from PANTHER. Briefly, reactions for which all involved PhysicalEntities (in input, output and catalyst) have a mapped orthologue/paralogue (for complexes at least 75% of components must have a mapping) are inferred to the other species. High level events are also inferred for these events to allow for easier navigation.

[More details and caveats of the event inference in Reactome.](#) For details on PANTHER see also: <http://www.pantherdb.org/about.jsp>

Preceded by: [p-T,Y MAPKs dimerize](#)

PEA15 binds MAPK monomers and dimers ↗

Location: [RAF/MAP kinase cascade](#)

Stable identifier: R-BTA-5675206

Type: binding

Compartments: cytosol

Inferred from: [PEA15 binds MAPK monomers and dimers \(Homo sapiens\)](#)

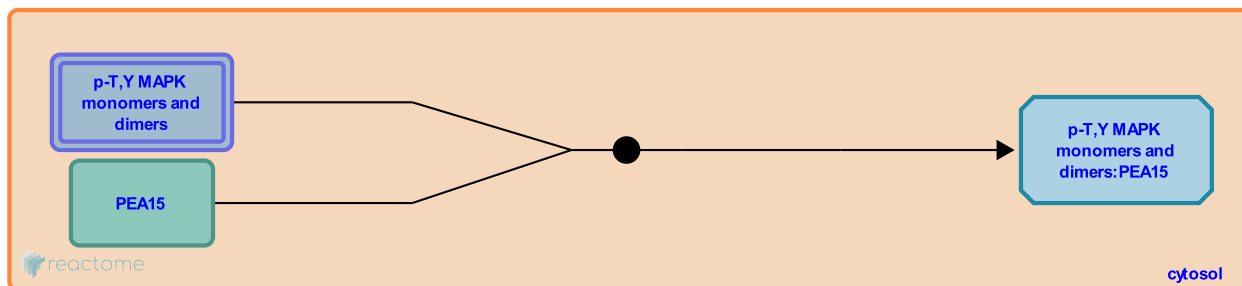

This event has been computationally inferred from an event that has been demonstrated in another species.

The inference is based on the homology mapping from PANTHER. Briefly, reactions for which all involved PhysicalEntities (in input, output and catalyst) have a mapped orthologue/paralogue (for complexes at least 75% of components must have a mapping) are inferred to the other species. High level events are also inferred for these events to allow for easier navigation.

[More details and caveats of the event inference in Reactome.](#) For details on PANTHER see also: <http://www.pantherdb.org/about.jsp>

Preceded by: [p-T,Y MAPKs dimerize](#)

Negative regulation of MAPK pathway ↗

Location: RAF/MAP kinase cascade

Stable identifier: R-BTA-5675221

Inferred from: Negative regulation of MAPK pathway (Homo sapiens)

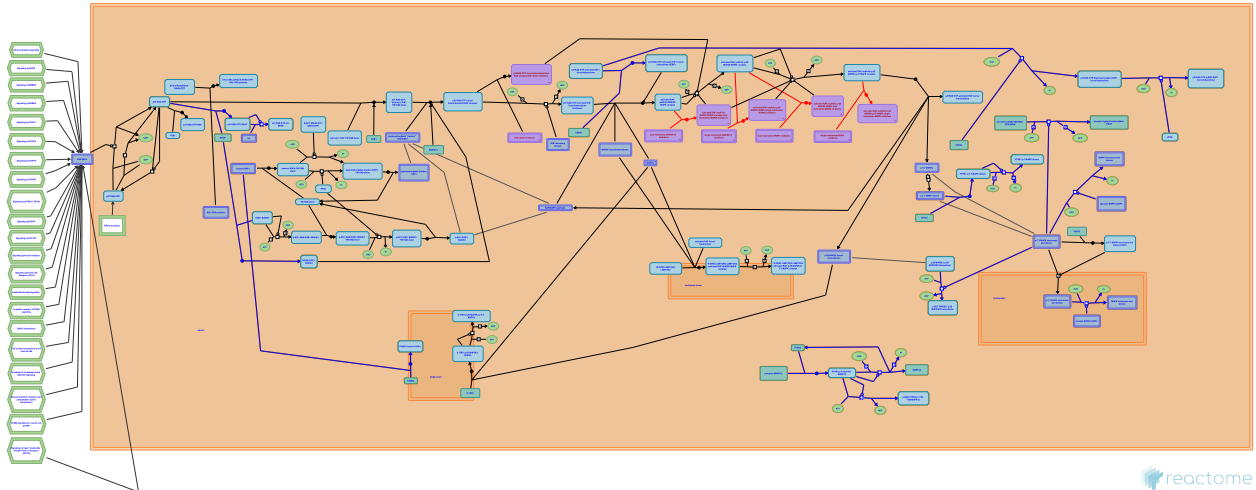

This event has been computationally inferred from an event that has been demonstrated in another species.

The inference is based on the homology mapping from PANTHER. Briefly, reactions for which all involved PhysicalEntities (in input, output and catalyst) have a mapped orthologue/paralogue (for complexes at least 75% of components must have a mapping) are inferred to the other species. High level events are also inferred for these events to allow for easier navigation.

[More details and caveats of the event inference in Reactome.](https://www.reactome.org) For details on PANTHER see also: <http://www.pantherdb.org/about.jsp>

Table of Contents

Introduction	1
▣ RAF/MAP kinase cascade	2
▣ RAS processing	3
↳ RAS intrinsic GTPase activity hydrolyzes GTP to GDP	4
↳ Intrinsic nucleotide exchange on RAS	5
↳ RAS GEFs promote RAS nucleotide exchange	6
↳ RAS:GTP binds PI3K	7
↳ RAS:GTP binds RAL GDS proteins	8
▣ RAF activation	9
▣ MAP2K and MAPK activation	10
↳ p-T,Y MAPKs dimerize	11
↳ Phosphorylated MAPKs translocate into the nucleus	12
↳ PEA15 binds MAPK monomers and dimers	13
▣ Negative regulation of MAPK pathway	14
Table of Contents	15